

**Bar Code
and
Magnetic Stripe Reader**

Model 2500

USER'S MANUAL



2190 Regal Parkway • Euless, TX 76040
(817) 571-9015 • (800) 648-4452 • FAX (817) 685-6232

FCC NOTICE

WARNING: This equipment generates, uses and can radiate radio frequency energy and if not installed and used in accordance with the instruction manual, may cause interference to radio communications. It has been tested and found to comply with the limits for a Class A computing device pursuant to Subpart J of Part 15 FCC Rules, which are designed to provide reasonable protection against such interference when operated in a commercial environment. Operation of this equipment in a residential area is likely to cause interference in which case the user at his own expense will be required to take whatever measures may be required to correct the interference.

TABLE OF CONTENTS

Introduction	1
Installation Instructions	2
Connecting the M2500 to the PC's Serial Port	8
Daisy Chain Instructions	9
Scanning Bar Codes	11
Wand Scanning	11
Laser Scanning	12
Installing and Using the MS941 Triggerless Laser	14
CCD Scanning	20
Slot Reader (Badge Reader)	21
Scanning Magnetic Stripes/Cards	22
Default Settings	23
Changing the Default Settings	25
Programming Guide	27
Code 39	28
UPC	29
EAN	30
UPC/EAN Supplements	31
Interleaved 2 of 5	32
Codabar	33
Code 128	33
Code 93	34
Code 11	34
MSI/Plessey	35
Serial Port	36
Preambles	39
Postambles	40
Termination Character	41
Beep Length and Tone	41
Mag Stripe Options #1	42
Mag Stripe Options #2	44
Bar Code Edit	46
Options #1	47
Options #2	49
Diagnostics	50
Cloning Setup Information	51
Specifications	54
Signal Definitions	55
Appendix A - Function & Special Keys	A-1
Appendix B - External Power Supply Requirements	B-1
Appendix C - Code 39 Specifications	C-1
Appendix D - Full ASCII Extension to Code 39	D-1
Appendix E - UPC Specifications	E-1
Appendix F - EAN Specifications	F-1

TABLE OF CONTENTS (Cont)

Appendix G - Interleaved 2 of 5 Specifications	G-1
Appendix H - Codabar Specifications	H-1
Appendix I - Code 128 Specifications	I-1
Appendix J - Code 93 Specifications	J-1
Appendix K - Card Data Format for Transaction Cards	K-1
Appendix L - Sources of Bar Code and Magnetic Stripe Standards	L-1

INTRODUCTION

The Model 2500 bar code and magnetic stripe reader combines features found in a variety of readers into one compact, easy to use system. The reader installs quickly between the terminal and host computer. Data is sent to the computer as if it were typed in from the terminal's keyboard. No software changes are necessary.

The reader accepts a wide variety of input devices such as a LASER, CCD, WAND, and MAGNETIC STRIPE READER. The Model 2500 allows up to three input devices maximizing the versatility of the reader system.

Tailor the reader to individual applications by simply scanning a bar code from the menu. It's that simple! All these features make the Model 2500 an ideal data collection device that provides quality and performance in one package.

FEATURES:

- Bar Code and Magnetic Stripe Data appear as Keyboard Data.
- Reader Automatically Recognizes and Reads the following Bar Code Types:
 - Code 3 of 9 (Code 39) - CODABAR
 - Extended Code 3 of 9 (Full ASCII) - Code 128
 - Interleaved 2 of 5 - Code 93
 - UPC-A, UPC-E(0), UPC-E(1) - Code 11
 - EAN-8, EAN-13 - MSI/PLESSEY
 - UPC & EAN Supplements
(2 and 5 Character)
- Power/Ready Light Indicating Scanner Status
- Reads Magnetic Stripes (Credit Cards, ID Cards, etc.)
- Supports Multiple Input Devices (Lasers, CCD, Wand, Slot Reader)

INSTALLATION INSTRUCTIONS

OVERVIEW

Installation requires connecting cables between the reader, your computer, and terminal.

NOTE: Before installing the bar code reader, you must have an operational RS-232 serial cable connected between the terminal and host computer system. The terminal **MUST** be able to communicate to the host system correctly **BEFORE** installing the bar code reader.

Step 1: Disconnect the existing RS-232 cable from the rear of the terminal. (This cable is the serial cable originally connected between the terminal and host computer system).

Step 2: The bar code reader comes with the following cable assemblies:

TERMINAL CABLE ASSEMBLY = 9 pin plug (male) to 25 pin plug (male)

HOST CABLE ASSEMBLY = 9 pin plug (male) to 25 pin socket (female)

Plug the 9 pin end of the TERMINAL CABLE ASSEMBLY into the connector labeled "TERMINAL" located on the rear panel of the reader.

Step 3: Plug the other end of the TERMINAL CABLE ASSEMBLY (the 25 pin male) into the rear of the terminal labeled "MODEM" or "MAIN".

Step 4: Plug the 9 pin end of the HOST CABLE ASSEMBLY into the connector labeled "HOST" located on the rear panel of the reader.

Step 5: Plug the other end of the HOST CABLE ASSEMBLY (the 25 pin female) into the original serial cable that was removed from the terminal.

Step 6: CONNECTING INPUT DEVICES:

Installing A Wand

Plug the end of the WAND cable into the circular connector labeled "WAND" on the front panel of the reader.

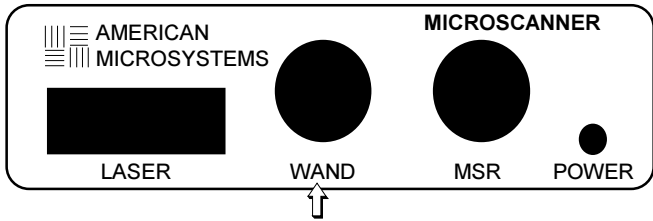

Installing A Laser Scanner

Plug the end of the LASER cable into the square connector labeled "LASER" located on the front panel of the reader.

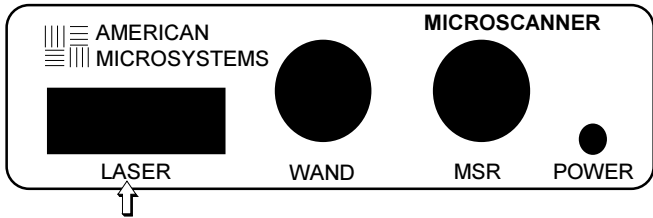

NOTE: A 12V LASER will require a 12V regulated external power supply. See the APPENDIX at the back of this manual for a description of "External Power Supply Requirements".

Installing A CCD Scanner

Plug the end of the CCD cable into the connector labeled "LASER" located on the front panel of the reader.

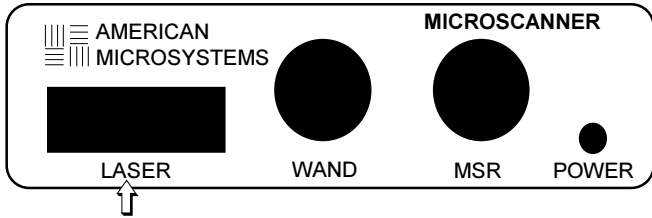

Installing A Magnetic Stripe Reader

Plug the end of the MAGNETIC STRIPE READER cable into the circular connector labeled "MSR" located on the front panel of the reader.

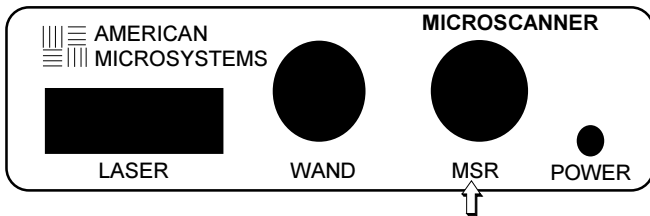

Installing A Slot Reader (*Badge Reader*)

Plug the end of the SLOT READER cable into the circular connector labeled "WAND" on the front panel of the reader.

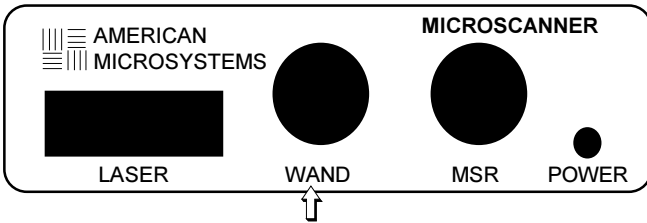

Step 7: Plug the power supply into the rear panel of the reader labeled "EXT POWER".

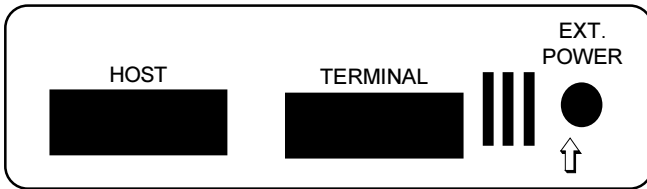

NOTE: A 12V LASER will require a 12V regulated external power supply. See the APPENDIX at the back of this manual for a description of "External Power Supply Requirements".

Step 8: Verify that the cables are connected as shown below:

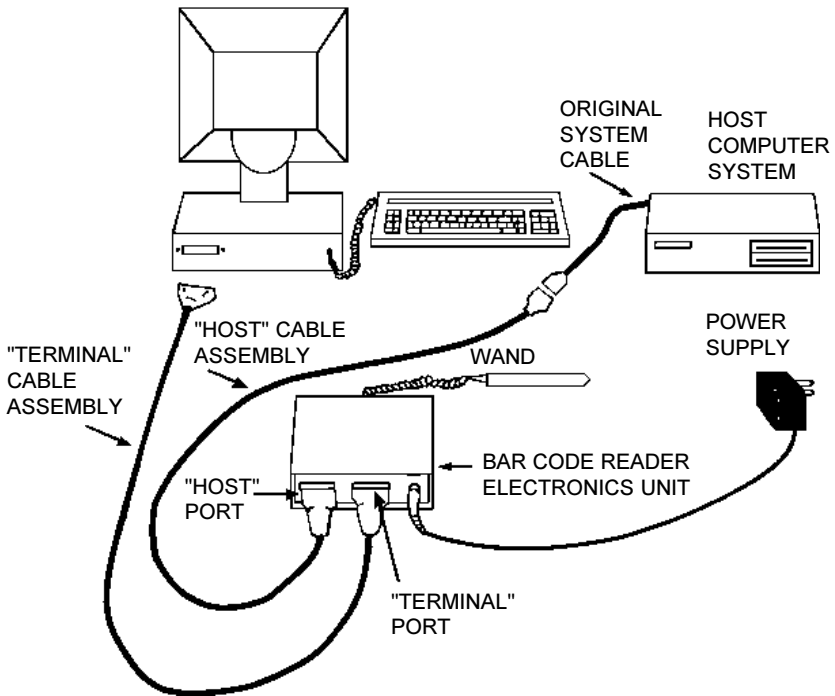
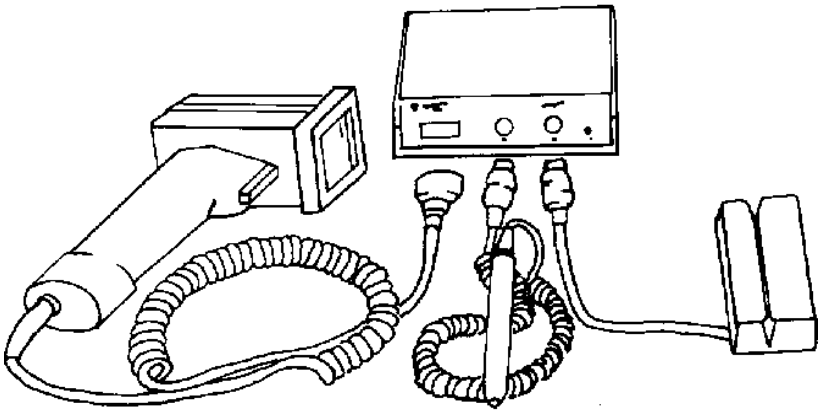

- Step 9:** With the power supply connected, the "POWER" display on the front panel of the reader will display RED and the reader will BEEP twice. Approximately 1/2 second later the display will change to GREEN.
- Step 10:** If the reader has been installed correctly, you should be able to type on the terminal's keyboard and communicate with the host computer system.
- Step 11:** The bar code reader is now operational and ready to use. The terminal is fully functional and you may enter data via the keyboard like you did prior to installation. To enter bar code data, simply scan the bar code and the data will be transmitted to the host system just like it was typed in from the terminal's keyboard.
- Step 12:** The reader is shipped from the factory with the serial port parameters set to the following defaults:

BAUD RATE:	9600
DATA BITS:	8
PARITY:	NONE
OUTPUT DATA:	ASCII
DUPLEX MODE:	FULL

NOTE: The reader's serial port parameters must be set to match the terminal. Check your terminal's serial port parameters against those listed above. If any parameters are different, the reader must be set to match the terminal. Proceed to the section of the manual entitled CHANGING THE DEFAULT SETTINGS.

CONNECTING THE MODEL 2500 TO THE PC'S SERIAL PORT

The Model 2500 can be connected to the PC's serial port and used as a standard RS-232 serial scanner.

Step 1: The bar code reader comes with two cable assemblies:

TERMINAL CABLE ASSEMBLY: 9 pin plug (male) to 25 pin plug (male)

HOST CABLE ASSEMBLY: 9 pin plug (male) to 25 pin socket (female)

To connect the bar code reader to the PC's serial port, only the **HOST CABLE ASSEMBLY** will be used. Plug the 9 pin end of the **HOST CABLE ASSEMBLY** into the connector labeled "**TERMINAL**" located on the rear panel of the bar code reader.

Step 2: Plug the other end of the **HOST CABLE ASSEMBLY** (the 25 pin female) into the PC's serial port (either COM1 or COM2).

Step 3: Set the bar code reader to **HALF DUPLEX MODE**. (See the Programming Guide section of the USER'S MANUAL).

Step 4: The **SOFTCOM** utility program is included with the Model 2500 which enables RS-232 serial data to appear as keyboard data to the PC. To install **SOFTCOM** on your PC, you must perform the following steps:

- Insert the **SOFTCOM** diskette into drive A on the PC.

- At the DOS prompt (C:>), type **A:** and press ENTER.

- At the A:> prompt, type **INSTALL** and press ENTER.

Step 5: Run the configuration program **SCONFIG** and set the serial port parameters to match those of the bar code reader.

Step 6: Run the program **SOFTCOM**. With **SOFTCOM** loaded, any data scanned with the bar code reader will appear as keyboard data to your program.

DAISY CHAIN INSTRUCTIONS

Daisy Chaining Using *SOFTCOM* Keyboard Emulation Software to Poll M2500's

1. Set *SOFTCOM* keyboard emulation software for daisy chaining.
2. Program each M2500 decoder with a unique daisy chain ID.

Daisy Chaining Using *SOFTCOM* Keyboard Emulation Software and a Master M2500 to Poll the Other M2500's in the Daisy Chain

1. Do not set *SOFTCOM* for daisy chaining.
2. Program the 1st M2500 (MASTER) to be the daisy chain Master Controller.
3. Program each daisy chained M2500 decoder with a unique daisy chain ID.

NOTE: The MASTER M2500 cannot be used for data entry.

Daisy Chaining Using an M2000/M2002 to Poll the M2500's in the Daisy Chain

1. Program the M2000/M2002 to be the Daisy Chain Master Controller.
2. Program each M2500 decoder with a unique daisy chain ID.

NOTE: Under most circumstances the M2000/M2002 should have the serial port programmed for 'PASS THROUGH' mode.

Daisy Chaining Using Your Own Polling Software

1. Each transmitted ID must be followed with a CARRIAGE RETURN <CR>.
2. If the decoder that is being polled has any data, it begins transmitting data within 2 characters time at the current baud rate.

EXAMPLE: Using 9600,N,8,1 as the Serial Port Parameters.

The decoder has an ID of '1', so the polling software sends a '1' + <CR> and waits for at least $(104 * 11 * 2) = 2288$ microseconds for the decoder box to start sending data. If the decoder box does not start sending data, then start the polling sequence for the next decoder. If data is received, allow a delay of 50 milliseconds following the last data character before polling again.

DAISY CHAIN CONNECTION DIAGRAMS

PC-M2500 Daisy Chain Using Softcom Communications Software as the Controller

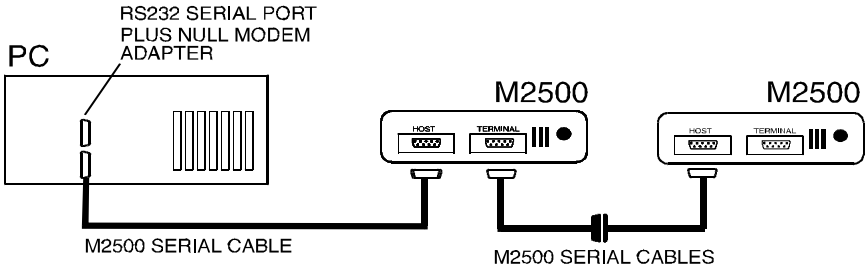

PC-M2500 Controller-M2500-M2500 Using M2500 Controller & Softcom Communication Software

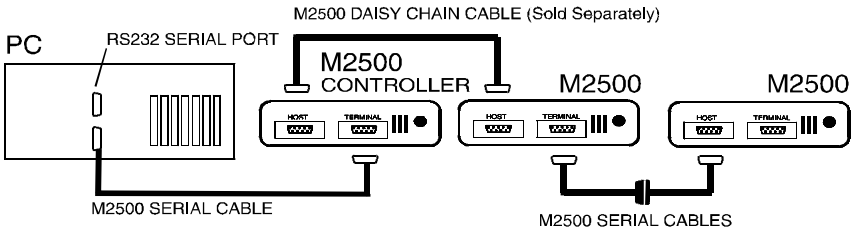

PC-M2000 Controller-M2500-M2500

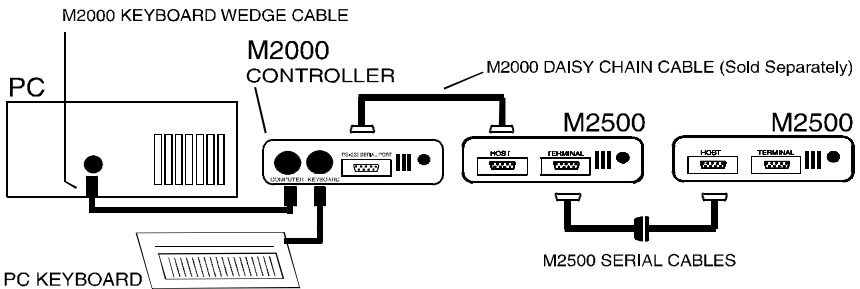

SCANNING BAR CODES

WAND SCANNING

- Step 1:** HOLD THE WAND LIKE A PENCIL, tilted at an angle of 10 to 30 degrees from vertical.
- Step 2:** TOUCH the wand tip to the WHITE SPACE before the label.
- Step 3:** Move the wand QUICKLY across the label as if you were drawing a straight line through the middle of it.
- Step 4:** Begin and end your stroke in the WHITE SPACE. Maintain a smooth, even stroke while scanning. You can read labels bi-directionally (either left-to-right or right-to-left) and the data will output correctly to your computer.
- Step 5:** If you scanned the label correctly, you will hear a short BEEP. When the "POWER" light turns GREEN the reader is ready to scan another label.

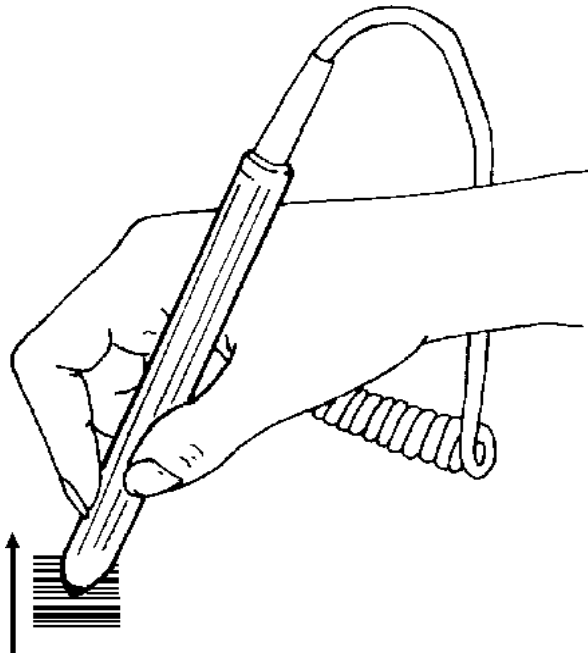

LASER SCANNING

****CAUTION****

ALTHOUGH THE LIGHT EMITTED FROM CLASS II AND CLASS IIA LASERS IS NOT CONSIDERED HAZARDOUS, AVOID STARING DIRECTLY INTO THE LIGHT BEAM. EXTENDED EXPOSURE MAY CAUSE DAMAGE TO YOUR EYES.

Step 1: AIM the LASER at a bar code label. Hold the LASER approximately 3 to 6 inches from the label.

NOTE: The maximum scanning distance depends on the label density. Typical scanning distances vary from 3 to 18 inches.

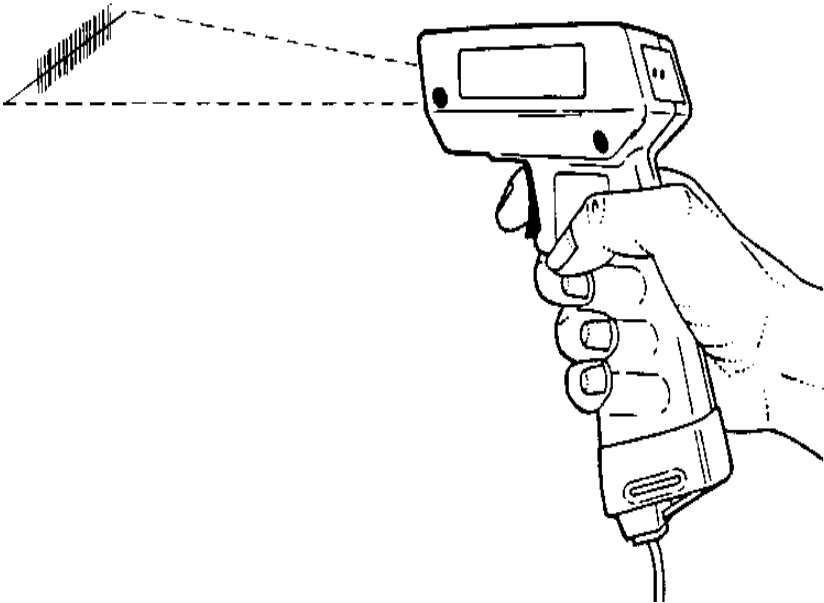

Step 2: SQUEEZE the TRIGGER on the laser. The front panel "POWER" light on the reader will change to RED and the "SCAN" light on the back of the laser will turn on. Simultaneously the laser will emit a thin red beam of light. The beam must cover the entire bar code label and part of the white area on both sides.

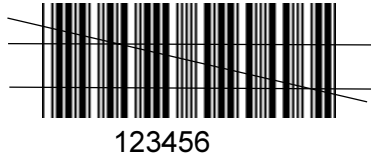

RIGHT



WRONG

Step 3: After a successful read the following will occur:

- The reader will BEEP.
- The "DECODE" light on the back of the laser will turn on.
- The reader will turn off the red beam of light.
- The bar code data is transmitted to the computer.

NOTE: If the laser has not read the label within approximately one second, it will turn off the beam. Try moving the laser closer to the bar code label and adjusting the pointing angle.

Step 4: When the front panel "POWER" light changes to GREEN, the reader is ready to scan another label.

INSTALLING AND USING THE MS941 TRIGGERLESS LASER

INSTALLATION

After installing the decoder box according to the instructions in the general "Installation Instructions" section, you are ready to connect the laser.

Step 1: Plug the end of the laser's cable into the square connector labeled "LASER" located on the front panel of the reader. See the diagram below:

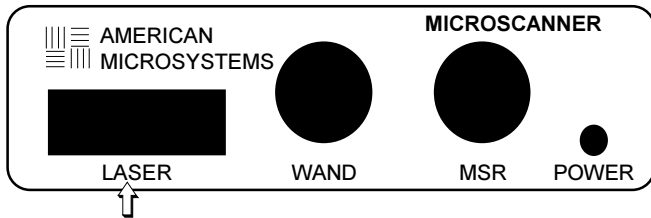

Step 2: For "hands-free" scanning, note the following:

The cradle can be removed from the stand and set on a horizontal surface (on its rubber feet), or mounted directly to a horizontal or vertical surface.

The cradle has magnets which hold the LASER in place.

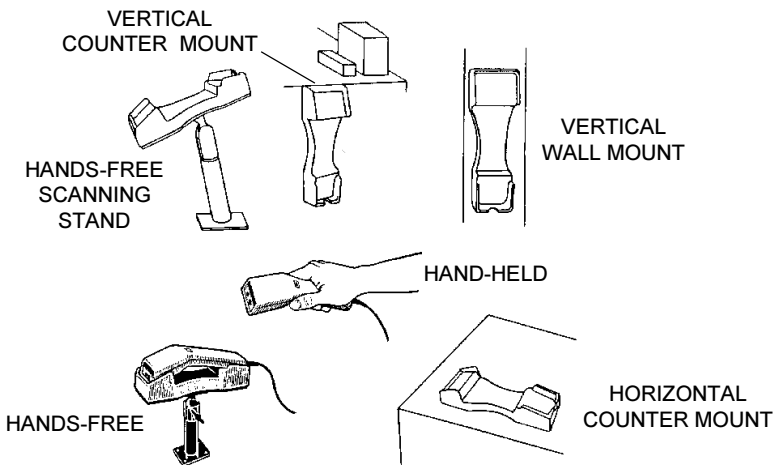

SCANNING WITH THE MS941 TRIGGERLESS LASER

The MS941 is a triggerless laser activated by a bar code or reflective object passing through its beam. It can be set in its cradle for "hands-free" operation, or held in the hand.

See the following steps for scanning instructions:

- Step 1:** Point the LASER at a bar code label or, for hands-free scanning, bring the bar code to the laser beam. The distance from the MS941 laser to the bar code should be approximately 1 to 5 inches.

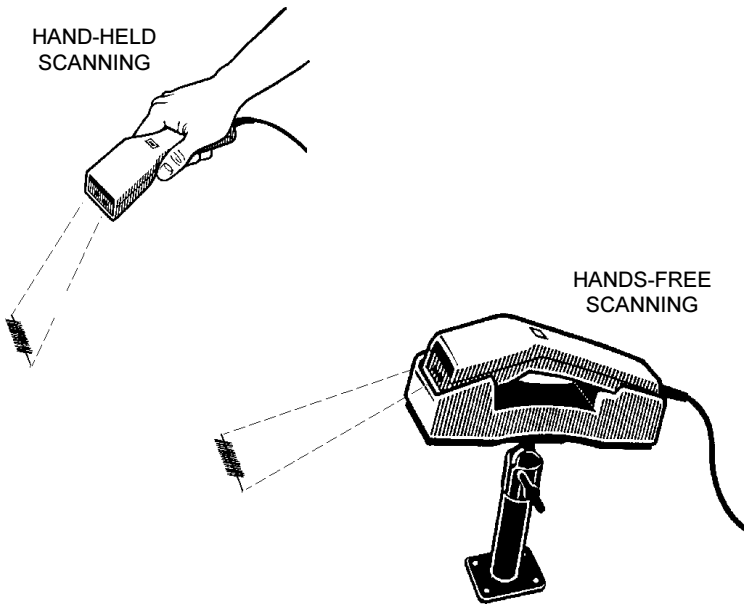

****CAUTION****

ALTHOUGH THE LIGHT EMITTED FROM CLASS II LASERS IS NOT CONSIDERED HAZARDOUS, AVOID STARING DIRECTLY INTO THE LIGHT BEAM. EXTENDED EXPOSURE MAY CAUSE DAMAGE TO YOUR EYES.

Step 2: The laser will begin scanning as soon as the bar code is brought within 5 inches of the front of the laser. The red light on the back of the LASER's handle will stay on as long as it is attempting a read. The laser beam must cover the entire bar code label and part of the blank area on both sides. Examples of bar code scans are shown below:

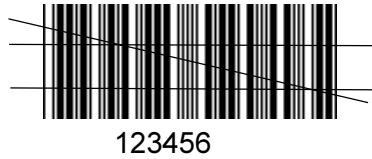

RIGHT



WRONG

Step 3: After a successful read the following will occur:

- The decoder will BEEP.
- The red light on the back of the laser will turn off.
- The green light on the back of the laser will turn on for the duration of the decoder's beep.
- The bar code data is transmitted to the computer.

SCANNING THE READER SETUP MENU WITH THE MS941 TRIGGERLESS LASER

In setting up the MS941 laser, using a wand or trigger-activated input device is recommended for scanning the READER SETUP MENU. If you do not have such an input device, you can use the MS941 Laser.

To facilitate using the MS941 in reading the MENU, the following suggestions are provided:

- 1) Curl the READER SETUP MENU from right to left (or the reverse), so that only one column of bar codes is exposed to the laser at a time.

OR

- 2) Use sheets of paper to cover bar codes adjacent to the one that is to be scanned.

NOTE: See the *"Changing the Default Settings"* section for detailed instructions on changing the settings.

SETTING UP THE MS941 TRIGGERLESS LASER

There are three separate modes of operation for the MS941 Laser. Descriptions of the operation and setup of each mode follow:

NON-CONTINUOUS SCANNING - DEFAULT MODE

Recommended Usage:

Recommended for general use. However, this mode requires the laser beam to be removed from any reflective surface between scans.

Operation Description:

The laser will power ON when it is brought within 5 inches of a reflective surface. It will scan until it reads the bar code, or reaches the time period specified in the LASER/CCD TIMEOUT option (the default is 1 second) before shutting off. For the next scan, the laser must momentarily be pointed away from any reflective surface, then brought back.

RE-READS: Accepts a re-read in the same manner as any other read.

Settings:

The following settings, which are the defaults, apply to this mode of operation:

Laser/CCD Timeout	1-9 sec
Laser/CCD Trigger Shutoff	ON
Laser/CCD Continuous Run	OFF

CONTINUOUS SCANNING - REFLECTIVE SURFACE REQUIRED

Recommended Usage:

Recommended for most applications; a highly efficient mode. Note that it is NOT recommended if the laser is constantly exposed to a reflective surface, such as a white counter top.

Operation Description:

The laser will power ON when it is brought within 5 inches of a reflective surface, and will continuously scan and read one bar code after another, until pointed away from any reflective surface. When pointed away from a reflective surface, the laser will continue to scan for the number of seconds specified in the LASER/CCD TIMEOUT option (the default is 1 second) before it shuts off.

RE-READS: Accepts a re-read after the amount of time specified in the CONTINUOUS RUN READ DELAY option (the default is 1 second) has passed.

Settings:

The following settings apply to this mode of operation:

Laser/CCD Timeout	1-9 sec
Laser/CCD Trigger Shutoff	ON
Laser/CCD Continuous Run	ON
Continuous Run Read Delay	0.1-9.9 sec

For optimum "hands-free" performance, set the LASER/CCD TIMEOUT option at 3-4 seconds.

CONTINUOUS SCANNING

NON-REFLECTIVE SURFACES ACCEPTED, "BLINK" MODE

Recommended Usage:

Recommended to be especially useful when there are non-reflective or colored scanning surfaces, or when bar code tags are small in size. Note that with this mode, any other bar code input devices that are connected to the decoder box will NOT operate.

Operation Description:

The laser will pulse on and off approximately two times a second. It will stop pulsing and scan continuously whenever it is brought within 5 inches of a bar code, and it will immediately read one bar code after another. When the laser is not exposed to any bar codes, it will continue to scan for the number of seconds specified in the LASER/CCD TIMEOUT option (the default is 1 second) before it resumes pulsing the beam on and off.

RE-READS: Accepts a re-read after the amount of time specified in the CONTINUOUS RUN READ DELAY option (the default is 1 second) has passed.

Settings:

The following settings apply to this mode of operation:

Laser/CCD Timeout	1-9 sec
Laser/CCD Trigger Shutoff	OFF
Laser/CCD Continuous Run	ON
Continuous Run Read Delay	0.1-9.9 sec

For optimum "hands-free" performance, set the LASER/CCD TIMEOUT option at 3-4 seconds.

CCD SCANNING

- Step 1:** Place the CCD scanner on the label or close to it (within one inch). Make sure the bar code label fits completely within the frame of the CCD opening.

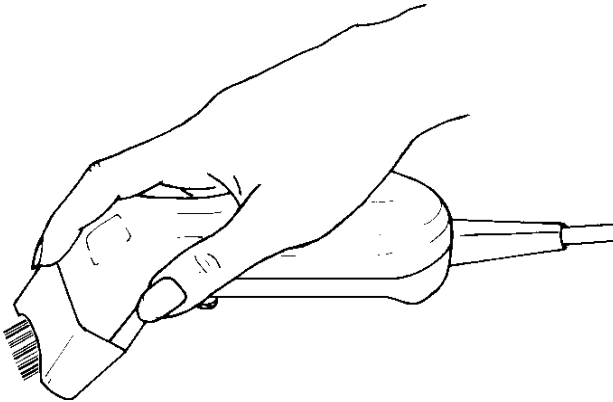

- Step 2:** PRESS the button on the CCD scanner. The front panel "POWER" light on the reader will change to RED.

- Step 3:** After a successful read the following will occur:
- The reader will BEEP.
 - The reader will turn off the red CCD light.
 - The bar code data is transmitted to the computer.

NOTE: If a read does not occur immediately, try moving the CCD closer to the bar code label and adjusting the pointing angle. If the reader has not read the label within the time period specified in the LASER/CCD TIMEOUT option (the default is 1 second), it will turn off the light beam.

- Step 4:** When the front panel "POWER" light changes to GREEN, the reader is ready to scan another label.

NOTE: For triggerless operation, refer to "LASER/CCD CONTINUOUS RUN and LASER/CCD TRIGGER SHUTOFF" options.

SLOT READER (Badge Reader)

Step 1: Hold the CARD so that the bar code label is on the bottom and FACES the ARROW on the slot reader.

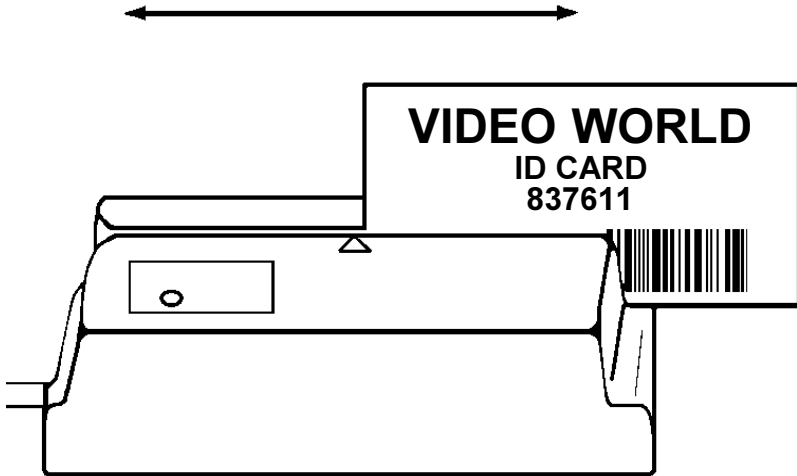

Step 2: Insert the CARD into the opening on either side of the reader.

Step 3: Holding the CARD flat against the bottom of the reader, SLIDE the card through the opening. You can slide the CARD bi-directionally (either left-to-right or right to left) and the data will output correctly to your computer. The CARD must maintain contact with the base of the reader while scanning. The front panel "POWER" light will change to RED while the card is being pulled through the SLOT READER.

NOTE: The center of the bar code must be positioned 0.5" from the bottom edge of the card.

Step 4: After a successful read the following will occur:

- The reader will BEEP.
- The bar code data is transmitted to the computer.

Step 5: When the front panel "POWER" light changes to GREEN, the reader is ready to scan another card.

SCANNING MAGNETIC STRIPES/CARDS

MAGNETIC STRIPE READER

To read a bar code label with a magnetic stripe reader, see the following steps:

Step 1: Hold the CARD so that the magnetic stripe is on the bottom and faces you.

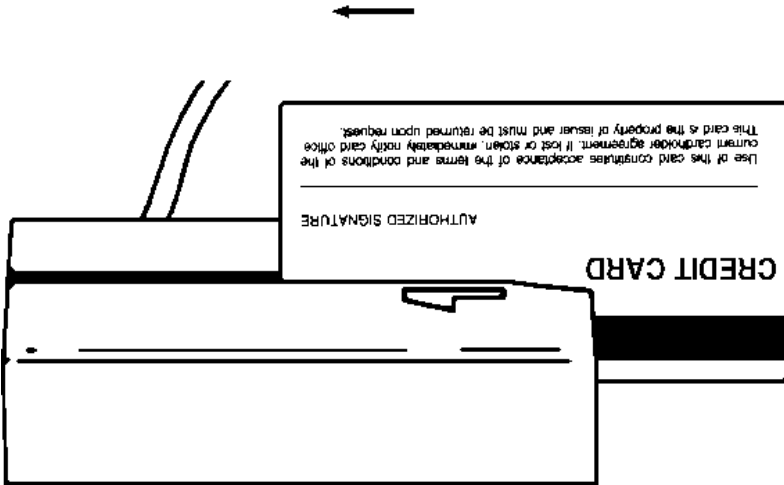

Step 2: Insert the CARD into the enlarged opening.

Step 3: Holding the CARD flat against the bottom of the reader, SLIDE the card in the direction of the arrows. The CARD must maintain contact with the base of the reader while scanning. The front panel "POWER" light on the reader will change to RED while the card is pulled through the reader.

Step 4: After a successful read the following will occur:

- The reader will BEEP.
- The magnetic stripe data is transmitted to the computer.

Step 5: When the front panel "POWER" light changes to GREEN, the reader is ready to scan another card.

DEFAULT SETTINGS

The Model 2500 is shipped from the factory with the following default settings:

CODE 39

CODE 39 DECODER ON
 FULL ASCII EXTENSION OFF
 MOD 43 CHECK DIGIT OFF
 SEND CHECK DIGIT OFF
 CONCATENATE MODE OFF

UPC

UPC DECODER ON
 CONVERT UPC-E TO UPC-A OFF
 CONVERT UPC-A TO EAN-13 OFF
 SEND UPC-A NUMBER SYSTEM ON
 SEND UPC-E NUMBER SYSTEM ON
 SEND UPC-A CHECK DIGIT ON
 SEND UPC-E CHECK DIGIT ON

EAN

EAN DECODER ON
 ZERO FILL EAN-8 TO EAN-13 OFF
 SEND EAN-13 COUNTRY CODE ON
 SEND EAN-8 COUNTRY CODE ON
 SEND EAN-13 CHECK DIGIT ON
 SEND EAN-8 CHECK DIGIT ON
 ISBN CONVERSION OFF

UPC/EAN SUPPLEMENTS

SUPPLEMENTS DECODER OFF
 ALLOW 2 DIGIT SUPPLEMENTS ON
 ALLOW 5 DIGIT SUPPLEMENTS ON
 REQUIRE SUPPLEMENTS OFF
 SEND SEPARATOR SPACE OFF

INTERLEAVED 2 OF 5

INT. 2 OF 5 DECODER ON
 CHECK DIGIT NONE
 SEND CHECK DIGIT OFF
 FIXED LENGTH OFF
 SET FIXED LENGTH #1 06
 SET FIXED LENGTH #2 00

CODABAR

CODABAR DECODER ON
 SEND START/STOP OFF
 CLSI FORMATTING OFF
 CLSI CHECK DIGIT OFF

CODE 128

CODE 128 DECODER ON
 UCC- 128 VERIFICATION OFF
 SEND MOD 10 CHECK DIGIT ON

CODE 93

CODE 93 DECODER ON
 CONCATENATE MODE OFF

MSI/PLESSEY

MSI/PLESSEY DECODER OFF
 TWO CHECK DIGITS REQUIRED OFF
 FIRST CHECK DIGIT MOD 11 OFF
 SEND 1ST CHECK DIGIT OFF
 SEND 2ND CHECK DIGIT OFF
 ISBN PLESSEY OFF

CODE 11

CODE 11 DECODER OFF
 TWO CHECK DIGITS REQUIRED OFF
 SEND 1ST CHECK DIGIT OFF
 SEND 2ND CHECK DIGIT OFF

SERIAL PORT

DATA TYPE	ASCII
DUPLEX MODE	FULL
INTER-CHARACTER DELAY	0 MSEC
DAISY CHAIN	OFF
SEND DAISY CHAIN ID	OFF
HOST RESPONSE	OFF
HOST RESPONSE TIMEOUT	0 SEC
HOST BEEP ENABLE	OFF
BAUD RATE	9600
DATA BITS	8
PARITY	NONE

POSTAMBLES

BAR CODE POSTAMBLE	NONE
MAG STRIPE POSTAMBLE	NONE
BAR CODE SEND DELAY	0 SEC
MAG STRIPE SEND DELAY	0 SEC
ACTIVE	ALL

MAG STRIPE #1

SEND ACCOUNT NUMBER	ON
SEND NAME (TRACK 1 ONLY)	ON
SEND EXPIRATION DATE	ON
SEND ALL TRACK DATA	ON
ENTER TRK 1 SEP CH	^
FORMAT EXP. DATE MMY	OFF
ENTER TRKS 2&3 SEP CH	=

OPTIONS # 1

SEND BAR CODE TYPE ID	OFF
DUPLICATE READS ALLOWED	ON
LASER/CCD TIMEOUT	1 SEC
LASER/CCD TRIGGER SHUTOFF	ON
LASER/CCD CONTINUOUS RUN	OFF
CONTINUOUS RUN READ DELAY	1 SEC
BAR CODE FUNCTION KEYS	OFF
KEYBOARD CAPS LOCK STATUS	ON

DIAGNOSTICS

DIAGNOSTIC SELF TEST	OFF
----------------------	-----

PREAMBLES

ENTER BAR CODE PREAMBLE	NONE
ENTER MAG STRIPE PREAMBLE	NONE
BAR CODE SEND DELAY	0.0 SEC
MAG STRIPE SEND DELAY	0.0 SEC
ACTIVE	ALL

TERMINATION CHARACTER

TERMINATION CHARACTER	CR
-----------------------	----

BEEP

LENGTH	MEDIUM SHORT
tone	MEDIUM HIGH

BAR CODE EDIT

BAR CODE EDITING	OFF
ENTER # OF LEADING STRIP CHAR'S	0
ENTER # OF TRAILING STRIP CHAR'S	0
ENTER BAR CODE TYPE TO EDIT	ALL
STRIP LEADING & TRAILING SPACES	OFF

MAG STRIPE #2

OUTPUT	BOTH
REQUIRE TWO TRACKS	OFF
SEND START & END SENTINELS	ON
BETWEEN TRACKS/FIELDS TERM CHAR	OFF
SEND ENDING TERMINATION CHAR	ON
STRIP SPACES	ON

OPTIONS # 2

BAR CODE SPECIAL KEYS	OFF
KEYBOARD NUM LOCK STATUS	OFF
MAG STRIPE SPECIAL/FUNCTION KEYS	OFF
BAR CODE TERM CHAR OVERRIDE	OFF

CHANGING THE DEFAULT SETTINGS

You can easily change the default settings by simply scanning the bar code options located on the READER SETUP MENU. The READER SETUP MENU is a laminated sheet of bar codes supplied with this manual.

The basic programming sequence is:

START / CATEGORY / OPTION (0-9) / ON/OFF (or) NUMBER ONLY / EXIT

Follow the instructions below to change the settings.

- Step 1:** Scan the START label at the top left corner of the SETUP MENU. This puts the reader into the program mode.
- Step 2:** Scan one of the CATEGORY labels (i.e. Code 39, UPC, Baud Rate).
- Step 3:** Select the desired option by scanning one of the numeric labels (0 - 9).
- Step 4:** If there is an (ON/OFF) next to the description, scan an ON label to enable or OFF label to disable the option.

EXAMPLE: To enable the MOD 43 check digit on Code 39, perform the following:

- 1) Scan the "CODE 39" category label.
- 2) Scan option "2" label to select "MOD 43 CHECK DIGIT" option.
- 3) Scan the "ON" label to enable it.

If there is a range of numbers next to the option, then scan one of the numeric labels (0 -9).

EXAMPLE: To select the OPCC check digit for Interleaved 2 of 5, perform the following:

- 1) Scan the "INT. 2 of 5" category label.
- 2) Scan the "1" label to select the "CHECK DIGIT" option.
- 3) Scan the "2" label to select OPCC.

Step 5: If you want to make another change within the SAME CATEGORY, you can scan another option number (i.e., return to Step 3 above). If you want to make a change in a DIFFERENT CATEGORY you MUST scan the new CATEGORY (i.e., return to Step 2 above and repeat the steps).

- Step 6:** When you have finished making all of the changes, you can either:
- 1) SCAN the EXIT (Save Changes) label to save all the changes

OR
- 2) SCAN the EXIT (Ignore Changes) label to exit without saving any changes.

NOTE: You can reset the reader to the default settings by performing the following:

- 1) Scan the START label.
- 2) Scan the RESET ALL DEFAULTS label.
- 3) Scan the EXIT (Save Changes) label.

PROGRAMMING GUIDE

START

The START bar code places the reader into the program mode. After scanning this label, the reader will emit three short BEEPS to indicate that it is in the program mode.

EXIT (SAVE CHANGES)

Scan this bar code to EXIT the program mode and save all of the changes. After scanning this label, the reader will BEEP twice then delay approximately one second and emit three short BEEPS to indicate that it accepted the changes.

EXIT (IGNORE CHANGES)

Scan this bar code to EXIT the program mode and DISCARD all of the current changes. The reader will use the settings that were in effect before entering the program mode.

RESET ALL DEFAULTS

Scan this bar code to RESET all options to their DEFAULT settings.

NOTE: Defaults are marked with "*".

0-9 BAR CODES

These bar codes are scanned to select various options and enter programmable data into the reader.

NOTE: Scan option (9) to reset all of the options within the current CATEGORY back to their defaults.

ON

If the OPTION has an (ON/OFF) beside the description, scan the ON bar code to turn ON the current option.

OFF

If the OPTION has an (ON/OFF) beside the description, scan the OFF bar code to turn OFF the current option.

FULL ASCII CHART

The FULL ASCII CHART is located on the back of the READER SETUP MENU. This chart contains the entire ASCII character set (128 characters). Use this chart to enter PREAMBLE and POSTAMBLE character strings as well as the RECORD TERMINATOR and SEPARATOR characters.

ADDITIONAL NOTES:

If the description beside the OPTION contains:

(ON/OFF) Then scan either an ON or OFF label to set the option.

(CHART) Then scan one or more characters from the Full ASCII Chart.

(0-9) Scan the desired character from the 0-9 labels.

(0.0-9.9) Scan two characters from the 0-9 labels to set the time from 0 to or (0.0-99) 9.9 seconds, or 0 to 99 seconds.

CODE 39

0) CODE 39 DECODER

ON* Enable reading CODE 39 labels.

OFF Disable reading CODE 39 labels.

1) FULL ASCII

ON Enable the FULL ASCII EXTENSION to CODE 39. Option #0 above must be set ON.

OFF* Disable the FULL ASCII EXTENSION to CODE 39. This sets the reader to the standard CODE 39 mode.

2) MOD 43 CHECK DIGIT

ON Enable the MOD 43 CHECK DIGIT for CODE 39. When this option is enabled, only CODE 39 labels that contain a valid check digit will be read.

OFF* Disable the MODE 43 CHECK DIGIT. Check digit verification will not be performed.

3) SEND CHECK DIGIT

ON Transmit the MOD 43 CHECK DIGIT with the bar code data. Requires option #2 above to be set ON.

OFF* Do not transmit the MOD 43 CHECK DIGIT.

4) CONCATENATE MODE

ON Enable CONCATENATE MODE. The concatenate mode allows the reader to accumulate multiple bar codes in its buffer, then send them to the computer just like they were a single bar code. When a Code 39 label containing a leading space is read, the reader emits two short beeps and buffers the data without transmission. This process continues until a Code 39 label without a leading space is read or 128 characters are buffered. A Code 39 bar code label that only contains a single or multiple dashes (minus sign) will clear the buffer.

OFF* Disable CONCATENATE MODE.

UPC

0) UPC DECODER

ON* Enable reading UPC-A and UPC-E labels.

OFF Disable reading UPC-A and UPC-E labels.

1) CONVERT UPC-E TO UPC-A

ON Convert all UPC-E labels to their UPC-A equivalents before transmission. After conversion, the reader will follow the UPC-A programming options.

OFF* No conversions will be performed.

2) CONVERT UPC-A TO EAN-13

ON Convert all UPC-A labels to an equivalent EAN-13 format by inserting a leading zero. After conversion, the reader will follow the EAN-13 programming options.

OFF* No conversions will be performed.

3) SEND UPC-A NUMBER SYSTEM

ON* Transmit the UPC-A NUMBER SYSTEM character.

OFF Do not transmit the UPC-A NUMBER SYSTEM character.

4) SEND UPC-E NUMBER SYSTEM

ON* Transmit the UPC-E NUMBER SYSTEM character.

OFF Do not transmit the UPC-E NUMBER SYSTEM character.

5) SEND UPC-A CHECK DIGIT

ON* Transmit the UPC-A CHECK DIGIT character.

OFF Do not transmit the UPC-A CHECK DIGIT character.

6) SEND UPC-E CHECK DIGIT

ON* Transmit the UPC-E CHECK DIGIT character.

OFF Do not transmit the UPC-E CHECK DIGIT character.

EAN

0) **EAN DECODER**

ON* Enable reading EAN-8 and EAN-13 labels.

OFF Disable reading EAN-8 and EAN-13 labels.

1) **ZERO FILL EAN-8 TO EAN-13**

ON Add five leading zeroes to EAN-8 labels. After conversion, the reader will follow the EAN-13 programming options.

OFF* No conversion is performed.

2) **SEND EAN-13 COUNTRY CODE**

ON* Transmit the EAN-13 COUNTRY CODE.

OFF Do not transmit the EAN-13 COUNTRY CODE.

3) **SEND EAN-8 COUNTRY CODE**

ON* Transmit the EAN-8 COUNTRY CODE.

OFF Do not transmit the EAN-8 COUNTRY CODE.

4) **SEND EAN-13 CHECK DIGIT**

ON* Transmit the EAN-13 CHECK DIGIT character.

OFF Do not transmit the EAN-13 CHECK DIGIT character.

5) **SEND EAN-8 CHECK DIGIT**

ON* Transmit the EAN-8 CHECK DIGIT character.

OFF Do not transmit the EAN-8 CHECK DIGIT character.

6) **ISBN CONVERSION**

ON Convert 13 DIGIT BOOKLAND/EAN (978 prefix) to its corresponding 10 DIGIT ISBN number.

EXAMPLE: BAR CODE DATA = 9780806957906
ISBN OUTPUT DATA = 0806957905

OFF* Do not convert Bookland/EAN to an ISBN number.

UPC/EAN SUPPLEMENTS

0) SUPPLEMENTS DECODER

ON Enable reading UPC & EAN supplements.

OFF* Disable reading UPC & EAN supplements.

1) ALLOW 2 DIGIT

ON* Enable reading 2 digit supplements. Option 0 above must be set ON.

OFF Disable reading 2 digit supplements.

2) ALLOW 5 DIGIT

ON* Enable reading 5 digit supplements. Option 0 above must be set ON.

OFF Disable reading 5 digit supplements.

3) REQUIRE SUPPLEMENTS

Specifies how the reader will handle various supplements.

0)* UPC/EAN bar codes will be read with or without valid supplements.

1) UPC bar codes will not be read unless they are accompanied by a valid supplement.

2) EAN bar codes will not be read unless they are accompanied by a valid supplement.

3) Bookland EAN bar codes will not be read unless they are accompanied by a valid supplement.

4) All UPC/EAN bar codes will not be read unless they are accompanied by a valid supplement.

4) SEND SEPARATOR SPACE

ON Insert a space between the standard bar code data and the supplemental data.

OFF* No separator space is inserted.

INTERLEAVED 2 OF 5

0) 1 2 OF 5 DECODER

ON* Enable reading INTERLEAVED 2 of 5 labels.

OFF Disable reading INTERLEAVED 2 of 5 labels.

1) CHECK DIGIT: 0=NONE, 1=USS, 2=OPCC

Specifies which type of check digit will be used with INTERLEAVED 2 of 5:

0* = NONE (no check digit required)

1 = UNIFORM SYMBOLOGY SPECIFICATION
(3-1-3 MOD 10)

2 = OPTICAL PRODUCT CODE COUNCIL
(2-1-2 MOD 10)

2) SEND CHECK DIGIT

ON Transmit the INTERLEAVED 2 of 5 check digit with the bar code data.

OFF* The check digit is not transmitted.

3) FIXED LENGTH

ON Read only FIXED LENGTH INTERLEAVED 2 of 5 bar code labels that match the lengths defined in options #4 & #5 below. The check digit can be on or off.

OFF* Disable FIXED LENGTH mode. Read all INTERLEAVED 2 of 5 labels without regard to length.

4) SET FIXED LENGTH #1 (02-60)

Sets the first valid FIXED LENGTH for Interleaved 2 of 5. Scan a two digit value to enter the length. Valid lengths are 02 to 60 characters. By definition, the length of Interleaved 2 of 5 labels are an even number of characters. The default FIXED LENGTH is 6 characters.

5) SET FIXED LENGTH #2 (02-60)

Sets a second valid fixed LENGTH for Interleaved 2 of 5. Scan a two digit value to enter the length. The default length is set to 0 characters (i.e. the second FIXED LENGTH is disabled).

CODABAR

0) CODABAR DECODER

ON * Enable reading CODABAR labels.

OFF Disable reading CODABAR labels.

1) SEND START/STOP

ON Transmit the CODABAR start/stop characters.

OFF * Do not transmit the CODABAR start/stop characters.

2) CLSI FORMATTING

ON The reader will insert a blank after the 1st, 5th, and 10th characters of a 14-character CODABAR label. The label length does not include the start and stop characters.

OFF * Disable CLSI formatting.

3) CLSI CHECK DIGIT

ON Enable the CLSI check digit. When this option is enabled, all fourteen digit numeric bar codes must contain a valid check digit.

OFF* Disable the CLSI check digit. Check digit verification will not be performed.

CODE 128

0) CODE 128 DECODER

ON * Enable reading Code 128 labels.

OFF Disable reading Code 128 labels.

1) UCC-128 VERIFICATION

ON A valid MOD 10 CHECK DIGIT is required on UCC-MOD 10 bar codes. (Applies to 20-digit serial shipping container bar codes.)

OFF * UCC-MOD 10 bar codes are accepted without valid MOD 10 CHECK DIGITS.

2) SEND MOD 10 CHECK DIGIT

ON * Transmit the MOD 10 CHECK DIGIT with the bar code entry.

OFF Do not transmit the MOD 10 CHECK DIGIT.

CODE 93

0) **CODE 93 DECODER**

- ON* Enable reading Code 93 labels.
- OFF Disable reading Code 93 labels.

1) **CONCATENATE MODE**

- ON Enable CONCATENATE MODE. The concatenate mode allows the reader to concatenate multiple bar codes in its buffer, then send them to the computer just like they were a single bar code. When a Code 93 label with a leading space is read, the reader emits two short beeps and buffers the data without transmission. This process continues until a Code 93 label without a leading space is read or 128 characters are buffered. A Code 93 bar code label that only contains a single or multiple dashes (minus sign) will clear the buffer.
- OFF* Disable CONCATENATE MODE.

CODE 11

0) **CODE 11 DECODER**

- ON Enable reading CODE 11 labels.
- OFF * Disable reading CODE 11 labels.

1) **TWO CHECK DIGITS REQUIRED**

- ON Two valid CHECK DIGITS are required for each label.
- OFF * One valid CHECK DIGIT is required for each label.

2) **SEND FIRST CHECK DIGIT**

- ON Transmit the FIRST CHECK DIGIT.
- OFF * Do not transmit the FIRST CHECK DIGIT.

3) **SEND SECOND CHECK DIGIT**

- ON Transmit the SECOND CHECK DIGIT.
- OFF * Do not transmit the SECOND CHECK DIGIT.

MSI/PLESSEY

0) MSI/PLESSEY DECODER

ON Enable reading MSI/PLESSEY labels.

OFF * Disable reading MSI/PLESSEY labels.

1) TWO CHECK DIGITS REQUIRED

ON Two valid CHECK DIGITS are required for each label.
The first check digit is defined by option (2) below.
The second check digit is always MOD 10.

OFF * One valid CHECK DIGIT is required for each label.
The CHECK DIGIT must be MOD 10.

2) FIRST CHECK DIGIT MOD 11

ON The FIRST CHECK DIGIT must be MOD 11.

OFF * The FIRST CHECK DIGIT must be MOD 10.

3) SEND FIRST CHECK DIGIT

ON Transmit the FIRST CHECK DIGIT.

OFF * Do not transmit the FIRST CHECK DIGIT.

4) SEND SECOND CHECK DIGIT

ON Transmit the SECOND CHECK DIGIT.

OFF * Do not transmit the SECOND CHECK DIGIT.

5) ISBN PLESSEY

ON Enable reading of Modified Plessey ISBN bar codes.
Only eleven digit ISBN bar codes will be read.

OFF* Do not read Modified Plessey ISBN bar codes.

SERIAL PORT

The RS-232C serial port transmits and receives data from both the host computer and the terminal. The reader's serial port parameters must match those of the terminal.

0) DATA TYPE: 0=ASCII 1=PC SCAN CODES

- 0* Sets the data format to ASCII characters. Use this mode with standard ASCII terminals.
- 1 Sets the data format to PC SCAN CODES. Use this mode only if you are using a "PC-Terminal" type terminal. This type of terminal transmits PC SCAN CODES to the host computer. Some operating systems that use these types of terminals are: PC-MOS, CONCURRENT DOS, etc.

1) DUPLEX MODE: 0=FULL 1=HALF

- 0* Selects FULL DUPLEX mode. In FULL DUPLEX, the reader transmits data out the HOST port only. The host computer receives the data and echoes it back to the terminal.
- 1 Selects HALF DUPLEX mode. In HALF DUPLEX, the readers transmits data out both the HOST and TERMINAL ports at the same time.

2) INTERCHARACTER DELAY (00 - 99 msec)

This option specifies the amount of delay to be inserted after transmitting each character. The delay period is programmable from 00 to 99 msec. This feature allows the user to slow the data rate down for host computers that require more time to process each character.

3) DAISY CHAIN (ON/OFF, ID)

This option specifies the Daisy Chain mode of operation.

- ON Enables Daisy Chain Controller operation. When enabled, the unit polls and accepts data from each M2500 that is in the daisy chain.
- OFF* Disables all Daisy Chain operations. M2500 operates as a stand alone unit.
- ID Designates the unique daisy chain ID. Accepts ID values from the Full ASCII Chart in the range of "SP" to "DEL" (ASCII 32-127).

4) SEND DAISY CHAIN ID (ON/OFF)

ON Sends the daisy chain ID at the beginning of data transmit, when in the daisy chain mode.

OFF* Does not send daisy chain ID.

5) HOST RESPONSE (ON/OFF)

ON Unit requires receipt of a Host Response after each data transmit. When used during daisy chain mode, the command must be preceded by the daisy chain ID.

OFF* Unit does not require a Host Response.

Valid Host Responses are:

CTRL G (ASCII 7) - Single Beep.
CTRL R (ASCII 18) - High/Low warble tone.
CR (ASCII 13) - Data OK. No action needed.

6) HOST RESPONSE TIMEOUT (00-99 SEC)

This parameter specifies how long the M2500 will wait for the host response. If the response timeout is set to zero then the M2500 will wait indefinitely. If a response is not received within the timeout period, the M2500 will continue scanning. The host response delay is programmable from 0-99 seconds.

7) HOST BEEP ENABLE (ON/OFF)

ON Enables receipt of commands from the Host Computer. These commands can be sent at any time.

CTRL G (ASCII 7) - Single Beep.
CTRL R (ASCII 18) - High/Low warble tone.

OFF* Disables Host Commands.

BAUD RATE

The baud rate sets the data transmission speed for the serial interface port on the reader. The reader's baud rate must match the terminal. Select one of the following:

- 0) 150
- 1) 300
- 2) 600
- 3) 1200
- 4) 2400
- 5) 4800
- 6)* 9600
- 7) 19,200
- 8) 38,400

PARITY

Sets the parity for the serial interface data. This setting must match the terminal. Select one of the following:

- 0)* NONE
- 1) EVEN
- 2) ODD
- 3) MARK

DATA BITS

Sets the character length (number of data bits per character) for the serial interface data. This setting must match the terminal. Select one of the following:

- 0) 7 BITS
- 1)* 8 BITS

PREAMBLES

PREAMBLE refers to a user-defined set of characters transmitted at the beginning of each type of input data. There are two different preambles. One set for bar code data, and one set for magnetic stripe data.

0) ENTER BAR CODE PREAMBLE

This set of user-defined characters is transmitted at the beginning of bar code data. To define this preamble, scan up to 15 characters from the FULL ASCII section of the MENU and then scan the "ON" bar code when you are done.

1) ENTER MAG STRIPE PREAMBLE

This set of user-defined characters is transmitted at the beginning of magnetic stripe data. To define this preamble, scan up to 15 characters from the FULL ASCII section of the MENU and then scan the "ON" bar code when you are done.

2) BAR CODE SEND DELAY (0.0 - 9.9 SEC)

This option specifies the amount of delay to occur after the bar code preamble is transmitted. The delay period is programmable from 0.0 to 9.9 seconds.

3) MAG SEND DELAY (0.0 - 9.9 SEC)

This option specifies the amount of delay to occur after the mag stripe preamble is transmitted. The delay period is programmable from 0.0 to 9.9 seconds.

4) ACTIVE TYPES

Specifies the types of bar codes that use preambles. Select one of the following:

- | | |
|----------------------|---------------|
| A CODE 39 | G CODABAR |
| B UPC-A | H CODE 128 |
| C UPC-E | I CODE 93 |
| D EAN-13 | J MSI/PLESSEY |
| E EAN-8 | K CODE 11 |
| F INTERLEAVED 2 of 5 | L ISBN |
| X* ALL BAR CODES | |

POSTAMBLES

POSTAMBLE refers to a user-defined set of characters transmitted at the end of each type of input data. There are two different postambles. One set for bar code data, and one set for magnetic stripe data.

0) ENTER BAR CODE POSTAMBLE

This set of user-defined characters is transmitted at the end of bar code data. To define this postamble, scan up to 15 characters from the FULL ASCII section of the MENU and then scan the "ON" bar code when you are done.

1) ENTER MAG STRIPE POSTAMBLE

This set of user-defined characters is transmitted at the end of mag stripe code data. To define this postamble, scan up to 15 characters from the FULL ASCII section of the MENU and then scan the "ON" bar code when you are done.

2) BAR CODE SEND DELAY (0.0 - 9.9 SEC)

This option specifies the amount of delay to occur after the bar code postamble is transmitted. The delay period is programmable from 0.0 to 9.9 seconds.

3) MAG SEND DELAY (0.0 - 9.9 SEC)

This option specifies the amount of delay to occur after the mag stripe postamble is transmitted. The delay period is programmable from 0.0 to 9.9 seconds.

4) ACTIVE TYPES

Specifies the types of bar codes that can accept appended postambles. Select one of the following:

- | | |
|----------------------|---------------|
| A CODE 39 | G CODABAR |
| B UPC-A | H CODE 128 |
| C UPC-E | I CODE 93 |
| D EAN-13 | J MSI/PLESSEY |
| E EAN-8 | K CODE 11 |
| F INTERLEAVED 2 of 5 | L ISBN |
| X* ALL BAR CODES | |

TERMINATION CHARACTER

The optional TERMINATION CHARACTER is transmitted at the end of the data. This option applies to bar code, mag stripe, and serial data.

If a USER DEFINED TERMINATION CHARACTER is desired, select setting (4) below, then scan a single character from the FULL ASCII section of the MENU.

- 0) NONE
- 1) HORIZONTAL TAB (ASCII 09)
- 2)* CARRIAGE RETURN (ASCII 13)
- 3) CARRIAGE RETURN & LINEFEED
(ASCII 13 & ASCII 10)
- 4) USER DEFINED TERMINATION CHARACTER

BEEP LENGTH & TONE

Settings (0-3) set the LENGTH of the BEEP. Settings (4-7) set the TONE (pitch) of the BEEP. Setting (8), when selected, will override the other BEEP selections and shut off the BEEP.

LENGTH:

- 0) SHORT
- 1)* MEDIUM SHORT
- 2) MEDIUM LONG
- 3) LONG

TONE:

- 4) LOW
- 5) MEDIUM LOW
- 6)* MEDIUM HIGH
- 7) HIGH

OFF:

- 8) NO BEEP

MAG STRIPE OPTIONS #1

0) SEND ACCOUNT NUMBER

(This option valid only if option (3) below is OFF.)

ON * Transmit the ACCOUNT NUMBER data from the magnetic card. On major credit cards, the account number is available on TRACKS 1 & 2.

OFF Do not transmit the ACCOUNT NUMBER.

1) SEND NAME (TRACK 1 ONLY)

(This option valid only if option (3) below is OFF.)

ON * Transmit the NAME data from the magnetic card. On major credit cards, the NAME is available only on TRACK 1.

OFF Do not transmit the NAME.

2) SEND EXPIRATION DATE

(This option valid only if option (3) below is OFF.)

ON * Transmit the EXPIRATION DATE. On major credit cards, the EXPIRATION DATE is available on TRACKS 1 & 2.

OFF Do not transmit the EXPIRATION DATE.

3) SEND ALL TRACK DATA

ON * Transmit ALL the data from each enabled track. The data is transmitted as it appears on the card with NO formatting. However, SEPARATOR CHARACTERS will be inserted between fields; see options (4) and (6) for information on SEPARATOR CHARACTERS.

OFF Disables this option.

NOTE: If this option is ON, it overrides options (0), (1), (2), and (5).

4) ENTER TRACK 1 SEPARATOR CHARACTER

(This option valid only if option (3) is ON.)

The TRACK 1 SEPARATOR CHARACTER, which separates the Track 1 fields, can be programmed by the user. Scan a single character from the FULL ASCII section of the MENU. The default is "^" (ASCII 94).

5) FORMAT EXPIRATION DATE MMY

(This option valid only if option (3) is OFF.)

ON EXPIRATION DATE format = MMY

OFF * EXPIRATION DATE format = YYMM

6) ENTER TRACKS 2 & 3 SEPARATOR CHAR

(This option valid only if option (3) is ON.)

The TRACKS 2 & 3 SEPARATOR CHARACTER, which separates the fields on tracks 2 and 3, can be programmed by scanning a single character from the FULL ASCII section of the MENU. The default is "=" (ASCII 61).

MAG STRIPE OPTIONS #2

0) OUTPUT

This option designates which track(s) will be output, and in what order. (To use a Dual Track decoder with a Single Track application, select FIRST TRACK (only) or SECOND TRACK (only)). Select one of the following:

- 0) FIRST TRACK (only)
- 1) SECOND TRACK (only)
- 2) * BOTH (output in order)
- 3) BOTH (REVERSE ORDER)

NOTE: For a dual track (tracks 2&3) mag stripe reader, FIRST TRACK represents track 2, and SECOND TRACK represents track 3.

1) REQUIRE TWO TRACKS

ON Two tracks of mag stripe data must be read for a "good read" to occur. (Only for use with dual track readers.)

OFF * The decoder will accept one (*or more*) valid tracks as a "good read".

NOTE: THIS OPTION MUST BE OFF FOR ALL SINGLE TRACK READERS. (Optional for dual track readers.)

2) SEND START & END SENTINELS

(This option valid only if SEND ALL TRACK DATA is ON.)

ON * The START/END SENTINEL characters for each enabled track will be transmitted. The characters for each type of sentinel are listed below:

- 1) Track 1 START SENTINEL = "% "
- 2) Tracks 2 & 3 START SENTINEL = "; "
- 3) Tracks 1, 2, & 3 END SENTINEL = "? "

OFF Do not transmit the START/END SENTINEL characters.

3) BETWEEN TRACKS/FIELDS TERM CHARACTER

The CHARACTER to be output is defined from the TERMINATION CHARACTER option. The default is a carriage return (ENTER).

- ON Transmit the TERMINATION CHARACTER between each track/field which is read. The insertion location is according to the following:
 - a) IF the SEND ALL TRACK DATA option is ON, the character will be inserted between TRACKS.
 - b) IF the SEND ALL TRACK DATA option is OFF, the character will be inserted between FIELDS.
- OFF * Do not transmit the BETWEEN TRACKS/FIELDS TERMINATION CHARACTER.

4) SEND ENDING TERMINATION CHARACTER

The CHARACTER to be output is defined from the TERMINATION CHARACTER option. The default is a carriage return (ENTER).

- ON * Transmit the TERMINATION CHARACTER after all data has been sent.
- OFF Do not transmit the ENDING TERMINATION CHARACTER.

5) STRIP SPACES

(This option valid only if SEND ALL TRACK DATA is OFF.)

- ON * All spaces will be stripped from the ACCOUNT NUMBER FIELD, and any leading or trailing spaces will be stripped from the NAME FIELD.
- OFF Do not strip any spaces from the mag stripe data.

BAR CODE EDIT

This option allows editing bar codes before transmittal.

0) **BAR CODE EDITING**

(Must be ON for any of the editing options below to be valid.)

ON Enable Bar Code Editing.

OFF * Disable Bar Code Editing.

1) **ENTER # OF LEADING CHAR TO STRIP (0-9)**

(Option (0) above must be ON.) Refers to the number (0-9) of bar code characters to be stripped, i.e., removed, from the beginning of the data entry.

2) **ENTER # OF TRAILING CHAR TO STRIP (0-9)**

(Option (0) above must be ON.) Refers to the number (0-9) of bar code characters to be stripped, i.e., removed, from the end of the data entry.

NOTE: If the total number of strip characters (both Leading and Trailing) is greater than the number of characters of the bar code, no characters will be stripped.

3) **ENTER BAR CODE TYPE TO EDIT**

(Option (0) above must be ON.) Refers to the type of bar codes for which editing can be enabled. Select one of the following:

A	CODE 39	G	CODABAR
B	UPC-A	H	CODE 128
C	UPC-E	I	CODE 93
D	EAN-13	J	MSI/PLESSEY
E	EAN-8	K	CODE 11
F	INTERLEAVED 2 of 5	X *	ALL BAR CODES

4) **STRIP LEADING & TRAILING SPACES**

(Option (0) above must be ON.)

ON Any LEADING & TRAILING SPACES will be stripped from the data.

OFF * No spaces will be stripped.

OPTIONS #1

0) SEND BAR CODE TYPE ID

ON Transmit the bar code identifier character at the beginning of the bar code data. There is one space between the ID character and the bar code data. The identifier characters are defined below:

A	CODE 39	G	CODABAR
B	UPC-A	H	CODE 128
C	UPC-E	I	CODE 93
D	EAN-13	J	MSI/PLESSEY
E	EAN-8	K	CODE 11
F	INTERLEAVED 2 of 5		

OFF * Do not transmit BAR CODE TYPE ID.

1) DUPLICATE READS ALLOWED

ON * Enable reading the same bar code multiple times.

OFF Disable reading the same bar code twice in a row.

2) LASER / CCD TIMEOUT (0 - 9)

If the LASER or CCD has not read a bar code within the designated time period, the device will be turned off. Select from 0 to 9 seconds. The default is 1 second.

CAUTION: IF THE ABOVE OPTION IS SET AT ZERO (0) SECONDS, IT WILL OVERRIDE THIS SAFETY FEATURE.

3) LASER / CCD TRIGGER SHUTOFF

ON * Releasing the trigger will turn off the LASER or CCD.

OFF The LASER or CCD will continue to run until a successful read or until the timeout period (from option (2), LASER/CCD TIMEOUT) lapses.

NOTE: To use "Blink Mode" with a CCD or laser, set this option OFF, and set option (4), LASER/CCD CONTINUOUS RUN, ON. (Note that "Blink Mode" will not operate properly for lasers which employ thermal shut-down.)

4) LASER / CCD CONTINUOUS RUN

- ON The LASER or CCD runs continuously as long as the trigger is pulled. The scanner will not be affected by the LASER/CCD TIMEOUT and will not shut off after a "good read".
- OFF * The LASER or CCD runs only when the trigger is pulled. (The LASER/CCD TIMEOUT option remains in effect.)

5) CONTINUOUS RUN READ DELAY (0.0 - 9.9 SEC)

(Valid only if option (4) above is ON.) This option sets the DELAY period between successive reads of the same bar code. This allows the removal of the bar code from the scan field without multiple reads. The default setting is 1.0 second. (To select a value, for example, 2.0, scan the "2" label, then the "0" label.)

6) BAR CODE FUNCTION KEYS

- ON Applies to BAR CODE data, preambles, postambles, and user defined termination characters. FUNCTION KEYS F1 through F10 will be transmitted in place of the ASCII characters "DC1" (11H) through "SUB" (1AH). The FUNCTION KEY values are listed in the Full ASCII Chart on back of the MENU, and in *Appendix A*.
- OFF * Disable FUNCTION KEYS.
(Standard ASCII characters are transmitted.)

NOTE: This option is applicable only if the "TRANSMIT DATATYPE = PC SCAN CODES" or if you are using *SOFTCOM* keyboard emulation software.

7) KEYBOARD CAPS LOCK STATUS

- ON * Scan ON to indicate that the keyboard's CAPS LOCK is turned ON. The result is lower case Alpha characters being output as Shifted characters.
- OFF Scan OFF to indicate that the keyboard's CAPS LOCK is turned OFF. The result is upper case Alpha characters being output as Shifted characters.

NOTE: This option is applicable only if the "TRANSMIT DATATYPE = PC SCAN CODES" or if you are using *SOFTCOM* keyboard emulation software.

OPTIONS #2

0) BAR CODE SPECIAL KEYS

This option applies only to BAR CODE data, preambles, postambles, and user defined termination characters.

ON SPECIAL KEY characters will be transmitted in place of a specific set of ASCII characters. The SPECIAL KEYS are listed in the Full ASCII Chart provided on back of the SETUP MENU and in *Appendix A*.

OFF * Disable SPECIAL KEYS. (Standard ASCII Characters are transmitted.)

EXAMPLE: With SPECIAL KEYS ON, the bar code character "STX" will be transmitted as a right arrow, having the effect of pressing the " " key at the keyboard.

NOTE: This option is applicable only if the "TRANSMIT DATA TYPE = PC SCAN CODES" or if you are using *SOFTCOM* keyboard emulation software.

1) KEYBOARD NUM LOCK STATUS

ON Scan ON to indicate that the keyboard's NUM LOCK is turned ON.

OFF * Scan OFF to indicate that the keyboard's NUM LOCK is turned OFF.

NOTE: This option is applicable only if the "TRANSMIT DATA TYPE = PC SCAN CODES" or if you are using *SOFTCOM* keyboard emulation software.

2) MAG STRIPE SPECIAL / FUNCTION KEYS

This option applies to MAG STRIPE data, preambles, postambles, and user-defined termination characters.

- ON SPECIAL KEYS and FUNCTION KEYS will be transmitted in place of a specific set of ASCII characters. The SPECIAL and FUNCTION KEY values are listed in the Full ASCII Chart provided on back of the SETUP MENU and in *Appendix A*.
- OFF * Disable SPECIAL / FUNCTION KEYS.
(Standard ASCII characters are transmitted.)

NOTE: This option is applicable only if the "TRANSMIT DATA TYPE = PC SCAN CODES" or if you are using *SOFTCOM* keyboard emulation software.

3) TERM CHAR OVERRIDE

- ON If any control character or special character (ie., function key, arrow key, etc...) is embedded in the bar code data, the TERMINATION CHARACTER, the PREAMBLE, and the POSTAMBLE will not be transmitted.
- OFF * The TERMINATION CHARACTER, the PREAMBLE, and the POSTAMBLE will be transmitted with all bar code data.

DIAGNOSTICS

This option executes a self-test program which performs the following tests on the reader:

- * EPROM Version Number
- * Internal and External Ram Test
- * EPROM Checksum Test
- * EEPROM Test
- * Character Set Test
- * Buzzer Test

The above tests are performed and their status is displayed on the terminal.

NOTE: Exit your application program and return to the operating system before enabling this test.

CLONING SETUP INFORMATION

When multiple readers are to be setup in the same configuration, it is advantageous to setup the first reader, and clone (copy) that setup to all the other units. The setup information can be (1), stored on a computer for cloning from computer to reader, or (2), cloned directly from one reader to another. These methods are described below:

CLONING FROM COMPUTER TO READER

BEFORE YOU START, HAVE THE FOLLOWING EQUIPMENT READY:

- A PC CLONE CABLE (with a 9 pin plug (male) and a 25 pin socket (female)).
- A communication software package must be installed on your computer, and it must have the following configuration settings:
 - BAUD RATE: must match the reader's setting
 - DATA BITS: 8 bits
- The configured reader, which is to send the clone information, must have the following configuration setting:
 - DATA BITS: 8 bits (the default setting)

NOTE: If the clone information has already been sent to your computer, start at step 10.

- Step 1:** Start with the configured reader (denoted as the "SOURCE" reader) connected to the computer's serial port..
- Step 2:** Plug the 9 pin end of the PC CLONE CABLE into the SOURCE reader's connector labeled "HOST", located on the rear panel of the reader.
- Step 3:** Scan the START bar code on the READER SETUP MENU.
- Step 4:** Plug the other end of the PC CLONE CABLE (the 25 pin female) into the computer's RS-232 serial port.
- Step 5:** At the computer, run your communications program and put it into RECEIVE mode.

Step 6: Scan the following "CLONE" bar code:

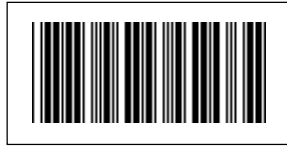

CLONE

Step 7: Once the clone information has been transmitted, take any steps required to save the information on the computer.

Step 8: From the SOURCE reader, scan EXIT (saving OR ignoring changes) on the READER SETUP MENU.

Step 9: Disconnect the SOURCE reader from all cables leading to the computer.

Step 10: Plug the 9 pin end of the PC CLONE CABLE into the reader which is to receive the clone information (denoted as the "TARGET" reader). The TARGET reader's connector, located on the rear panel, is labeled "HOST".

Step 11: At the computer, run the communications program. Note that the communications BAUD RATE must be set to match the TARGET reader's BAUD RATE (the default setting is 9600).

Step 12: Set the communications program to TRANSMIT. The reader will beep twice, pause, and beep three times more, indicating the following:

- 2 beeps: indicate the clone information was received
- 3 beeps: indicate the reader is now configured

Step 13: Now you are ready to disconnect the newly configured reader from all cables leading to the computer.

Step 14: Repeat steps 10 -14 for each additional reader to be cloned.

CLONING FROM READER TO READER

BEFORE YOU START, HAVE THE FOLLOWING EQUIPMENT READY:

- A READER CLONE CABLE (with two 9 pin male plugs).
- The two readers.
- The reader which is to receive the clone information must have the following configuration settings:
 - BAUD RATE: must match the configured reader's setting
 - DATA BITS: 8 bits (the default setting)

Step 1: Plug one end of the READER CLONE CABLE into the configured reader (denoted as the "SOURCE" reader). The SOURCE's connector, located on the rear panel of the reader, is labeled "HOST".

Step 2: Plug the other end of the READER CLONE CABLE into the reader which is to receive the clone information; this reader is denoted as the "TARGET". The TARGET's connector, located on the rear panel of the reader, is also labeled "HOST".

Step 3: From the "SOURCE" reader, scan the START bar code on the READER SETUP MENU.

Step 4: Still at the "SOURCE" reader, scan the following "CLONE" bar code:



CLONE

Step 5: The "TARGET" reader will beep twice, pause, and beep three times more, indicating it has received the clone information and is now configured.

Step 6: Disconnect the CLONE CABLE from the newly configured TARGET reader.

Step 7: For each additional reader to be cloned, connect a TARGET reader to the source reader and repeat steps 2 through 6.

Step 8: When cloning is complete, go to the SOURCE reader and scan EXIT (saving OR ignoring changes) on the READER SETUP MENU.

Step 9: Next, disconnect the CLONE CABLE from the SOURCE reader.

SPECIFICATIONS

BAR CODES SUPPORTED

Auto-discriminates between all of the following codes:

- Code 3 of 9 (Code 39)
- Extended Code 3 of 9 (Full ASCII)
- Interleaved 2 of 5 (Variable and Fixed Length, Check Digit)
- UPC-A (Including 2 and 5 Character Supplements)
- UPC-E(0), UPC-E(1)
- EAN/JAN (Including 2 and 5 Character Supplements)
- Codabar
- Code 128
- Code 93
- Code 11
- MSI/Plessey

INPUT DEVICES SUPPORTED

Lasers (Helium-Neon, Visible Laser Diode, Infrared)
CCD Scanners
Wands (Visible and Infrared)
Slot Readers (Or Badge Readers)
Magnetic Stripe Readers (Single or Dual Track)

USER PROGRAMMABLE FEATURES

All features are easily programmed with a bar code menu:

- | | | |
|-----------------------------|-------------------------------|------------------------------|
| Bar Code Selection: | Preambles/Postambles: | Laser Configuration: |
| • Enable/Disable | • Bar Code (15 Chars Max) | • Laser Time-Out |
| • Length | • Mag Stripe (15 Chars Max) | • Trigger Function |
| • Check Digit | • Transmit Delay | • Continuous Mode |
| • Start/Stop Transmit | | |
| Beep Tone and Length | Mag Stripe Data Format | Inter-Character Delay |

RS-232 SERIAL PORT

Baud Rates: 150, 300, 600, 1200, 2400, 4800, 9600, 19.2K, 38.4K
Parity: NONE, ODD, EVEN, MARK
Data Bits: 7 or 8
Signals: Transmit Data, Receive Data, Signal Ground, DTR, RTS, CTS, DSR, DCD

INDICATORS

Audio "BEEP" Indicates Successful Read
A Red/Green LED Indicates Status of Reader

POWER REQUIREMENTS

Power Consumption = 0.5 Watts. (12V Laser Requires 12V Regulated Supply)

CONNECTORS

Laser Input: 9 Pin "D" Style
Wand Input: 5 Pin DIN Style
Mag Stripe Input: 8 Pin DIN Style
RS-232 Interface: 25 Pin "D" Style
External Power Input: 2.5 mm Barrel Connector

ENVIRONMENTAL

Operating Temperature: 0° to +50° C
Storage Temperature: -30° to +70° C
Relative Humidity: 5% to 95%
(Non-Condensing)

PHYSICAL SPECIFICATIONS

Weight: 14 oz Width: 5 1/8 in
Length: 5 1/4 oz Height: 1 1/2 in

SIGNAL DEFINITIONS

WAND/MAG STRIPE INTERFACE

PIN	SIGNAL
1	+5V
2	DATA (<u>DATA</u> - MAG STRIPE)
3	GROUND
4	<u>CLOCK</u> (MAG STRIPE)
5	<u>CARD PRESENT</u> (MAG STRIPE)

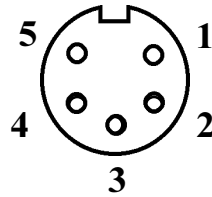

DUAL MAG STRIPE INTERFACE

PIN	SIGNAL
1	+5V
2	<u>DATA</u> , TRACK 2
3	<u>CLOCK</u> , TRACK 2
4	GROUND
5	<u>DATA</u> , TRACK 1
6	<u>CLOCK</u> , TRACK 1
7	<u>CARD PRESENT</u>
8	GROUND

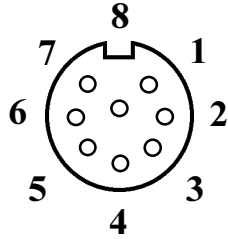

LASER INTERFACE

PIN	SIGNAL
1	SYNC
2	DATA
3	DECODE LED
4	NO CONNECTION
5	TRIGGER
6	HEAD ENABLE
7	GROUND
8	SHIELD GROUND
9	LASER POWER

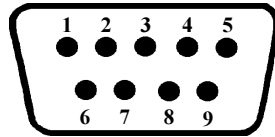

RS-232C HOST /TERMINAL INTERFACE

PIN	SIGNAL
1	FRAME GROUND
2	*TRANSMIT DATA
3	*RECEIVE DATA
4	REQUEST TO SEND
5	CLEAR TO SEND
6	DATA SET READY
7	SIGNAL GROUND
8	DATA CARRIER DETECT
9 (20)	DATA TERMINAL READY (pin 20 on the 25 pin cable assemblies)

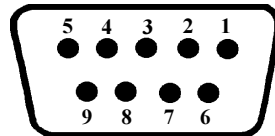

* Pin 2 from HOST is connected to Pin 3 of TERMINAL while
Pin 3 of HOST is connected to Pin 2 of TERMINAL.

EXTERNAL POWER SUPPLY INTERFACE

CONNECTOR: FEMALE BARREL 2.5mm x 5.5mm (9 - 12 VDC, center positive)



APPENDIX A - FUNCTION & SPECIAL KEYS

With FUNCTION KEYS enabled, the decoder can accept a given ASCII character and transmit a corresponding FUNCTION KEY to the computer. The ASCII characters and values are listed in the table below.

ASCII CHARACTERS	FUNCTION KEYS	ASCII VALUES
DC1	F1	17
DC2	F2	18
DC3	F3	19
DC4	F4	20
NAK	F5	21
SYN	F6	22
ETB	F7	23
CAN	F8	24
EM	F9	25
SUB	F10	26

SPECIAL KEYS

With SPECIAL KEYS enabled, the decoder can accept a given ASCII character and transmit a corresponding SPECIAL KEY to the computer. The ASCII characters and values are listed in the table below.

ASCII CHARACTERS	SPECIAL KEYS	ASCII VALUES
SOH	(Left Arrow)	1
STX	(Right Arrow)	2
ETX	(Up Arrow)	3
EOT	(Down Arrow)	4
ENQ	HOME	5
ACK	END	6
BEL	DELETE	7
VT	PAGE UP	11
FF	PAGE DOWN	12
SO	SHIFT ON	14
SI	SHIFT OFF	15
DLE	INS	16
FS	CTRL ON	28
GS	CTRL OFF	29
RS	ALT ON	30
US	ALT OFF	31

APPENDIX B - EXTERNAL POWER SUPPLY REQUIREMENTS

The MODEL 2500 can support both 12V and 5V LASERS (and CCD scanners). The power source for the "LASER" connector on the front panel of the reader is determined by a jumper located inside the enclosure.

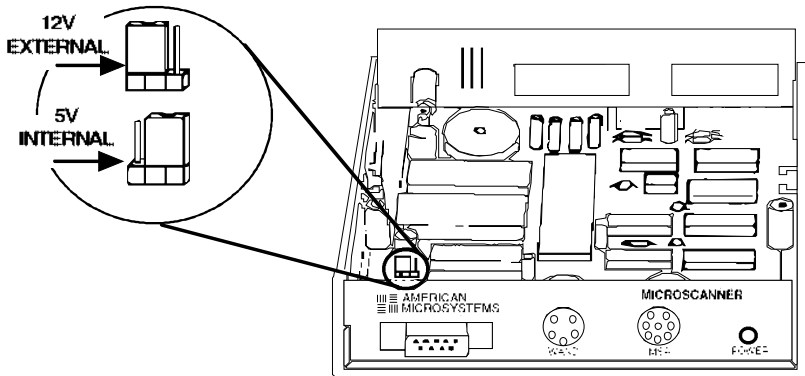

When the jumper is set to the 12V or EXTERNAL position, 12V power is taken directly from the external power supply. In this configuration an external 12V regulated power supply **MUST** be connected to the reader.

When the jumper is set to the 5V or INTERNAL position, 5V power is supplied to the laser interface.

The following table lists various configuration requirements:

INPUT DEVICE	POWER REQUIREMENT	JUMPER POSITION
LASER	12V	EXTERNAL
LASER	5V	INTERNAL
C C D	5V	INTERNAL

NOTE: The reader is shipped from the factory with the jumper set to the INTERNAL position. This will supply 5V to the laser.

APPENDIX C - CODE 39 SPECIFICATIONS

Code 39 is a variable length alphanumeric code. Each character is made up of nine elements, five bars and four spaces. Three of the elements are wide and six are narrow. Code 39 is a popular choice for applications because:

- it is easy to print with low cost dot matrix printers
- large character set (A-Z, 0-9, 7 special characters)
- code can be extended to include the entire 128 ASCII character set
- variable length



CHARACTERISTICS:

Character Set:	26 uppercase letters (A - Z) 10 digits (0 - 9) 7 special characters (SPACE -.\$/+%)
Symbol Length:	Variable
Check Digit:	Optional
Bi-directional Decoding:	Yes
Maximum Density:	9.8 char./inch (using .0075 inch narrow element)

CODE 39 CHARACTER SET:

Char-acter	Pattern	Bars	Spaces	Char-acter	Pattern	Bars	Spaces
1		10001	0100	M		11000	0001
2		01001	0100	N		00101	0001
3		11000	0100	O		10100	0001
4		00101	0100	P		01100	0001
5		10100	0100	Q		00011	0001
6		01100	0100	R		10010	0001
7		00011	0100	S		01010	0001
8		10010	0100	T		00110	0001
9		01010	0100	U		10001	1000
0		00110	0100	V		01001	1000
A		10001	0010	W		11000	1000
B		01001	0010	X		00101	1000
C		11000	0010	Y		10100	1000
D		00101	0010	Z		01100	1000
E		10100	0010	-		00011	1000
F		01100	0010	.		10010	1000
G		00011	0010	Space		01010	1000
H		10010	0010	*		00110	1000
I		01010	0010	\$		00000	1110
J		00110	0010	/		00000	1101
K		10001	0001	+		00000	1011
L		01001	0001	%		00000	0111

An optional check character can be used for applications requiring higher levels of data security. When used, the check character immediately follows the last data character. The check digit is calculated as follows:

1. Each data character is assigned a numerical value as shown in the following table:

CHAR	VALUE	CHAR	VALUE	CHAR	VALUE
0	0	F	15	U	30
1	1	G	16	V	31
2	2	H	17	W	32
3	3	I	18	X	33
4	4	J	19	Y	34
5	5	K	20	Z	35
6	6	L	21	-	36
7	7	M	22	.	37
8	8	N	23	SPACE	38
9	9	O	24	\$	39
A	10	P	25	/	40
B	11	Q	26	+	41
C	12	R	27	%	42
D	13	S	28		
E	14	T	29		

2. Sum all of the numerical values for each data character in the bar code.
3. Divide this sum by 43.
4. The remainder is the numerical value for the check digit. Use the table in step 1 to look-up the corresponding character.

EXAMPLE: Sample Code 39 data = A394T

1. Use the table to lookup the numerical value for each character.
2. $10 + 3 + 9 + 4 + 29 = 55$
3. $55 / 43 = 1$ remainder 12
4. Check digit numerical value = 12
The check digit = C.
Bar code with check digit = A394TC

APPENDIX D - FULL ASCII EXTENSION TO CODE 39

The FULL ASCII EXTENSION expands standard CODE 39 to include the entire 128 ASCII character set. This is accomplished by pairing standard CODE 39 characters. The \$, +, /, and % characters are paired as shown in the following table:

ASCII	CODE	ASCII	CODE	ASCII	CODE	ASCII	CODE
NUL	%U	!	/A	A	A	a	+A
SOH	\$A	"	/B	B	B	b	+B
STX	\$B	#	/C	C	C	c	+C
ETX	\$C	\$	/D	D	D	d	+D
EOT	\$D	%	/E	E	E	e	+E
ENQ	\$E	&	/F	F	F	f	+F
ACK	\$F	'	/G	G	G	g	+G
BEL	\$G	(/H	H	H	h	+H
BS	\$H)	/I	I	I	i	+I
HT	\$I	*	/J	J	J	j	+J
LF	\$J	+	/K	K	K	k	+K
VT	\$K	,	/L	L	L	l	+L
FF	\$L	-	-	M	M	m	+M
CR	\$M	.	.	N	N	n	+N
SO	\$N	/	/O	O	O	o	+O
SI	\$O	0	0 or /P	P	P	p	+P
DLE	\$P	1	1 or /Q	Q	Q	q	+Q
DC1	\$Q	2	2 or /R	R	R	r	+R
DC2	\$R	3	3 or /S	S	S	s	+S
DC3	\$S	4	4 or /T	T	T	t	+T
DC4	\$T	5	5 or /U	U	U	u	+U
NAK	\$U	6	6 or /V	V	V	v	+V
SYN	\$V	7	7 or /W	W	W	w	+W
ETB	\$W	8	8 or /X	X	X	x	+X
CAN	\$X	9	9 or /Y	Y	Y	y	+Y
EM	\$Y	:	/Z	Z	Z	z	+Z
SUB	\$Z	;	%F	[%K	{	%P
ESC	%A	<	%G	\	%L		%Q
FS	%B	=	%H]	%M	}	%R
GS	%C	>	%I	^	%N	~	%S
RS	%D	?	%J	_	%O	DEL	%T,%X,
US	%E	@	%V	`	%W		%Y or
SP	SPACE						%Z

APPENDIX E - UPC SPECIFICATIONS

The Universal Product Code (UPC) symbols can be found on almost all retail products today. The UPC coding system was designed to uniquely identify a product and its manufacturer.

UPC VERSION A

UPC-A is a fixed length (12 digits) numeric only code with the following features:

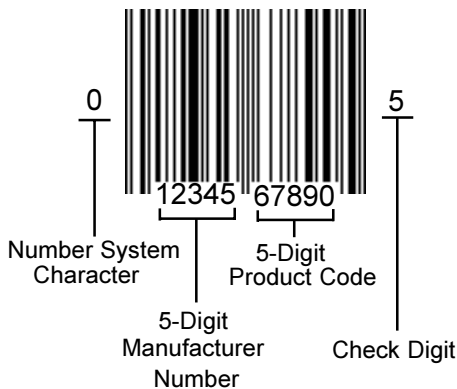

UPC-A BAR CODE

The NUMBER SYSTEM CHARACTER indicates the type of product the symbol is identifying:

- 0,7 Regular UPC codes with numbers assigned by the Uniform Code Council (see appendix on bar code sources).
- 2 Random-weight items such as meat and produce.
- 3 National Drug Code and National Health Related Items Code.
- 4 For in-store marking of non-food items.
- 5 Reserved for coupons.

- 1,6,8,9 Reserved for future use.

The last digit in UPC bar codes is a MODULO 10 CHECK DIGIT. It is calculated in the following manner:

1. From right to left, sum the digits in the odd positions.
2. Multiply this sum by 3.
3. From right to left, sum the digits in the even positions.
4. Add this sum to the product of step 2.
5. The modulo-10 check digit is the smallest number, which when added to the sum of Step 4 produces a multiple of 10.

EXAMPLE: UPC bar code = 01234567890C where C is the CHECK DIGIT.

1. Sum $0 + 8 + 6 + 4 + 2 + 0 = 20$
2. Multiply $20 \times 3 = 60$
3. Sum $9 + 7 + 5 + 3 + 1 = 25$
4. Sum $60 + 25 = 85$
5. $85 + 5 = 90$ (check digit = 5)
Therefore: UPC bar code - 012345678905

UPC VERSION E

UPC Version E is a six digit variation of the UPC symbology. The last digit indicates the type of compression used. Because of this data compression process, the version E symbol is often referred to as a zero-suppressed symbol.



The following table illustrates the expansion process for converting UPC-E to its UPC-A equivalent:

Version E Number	Insertion Digits	Insertion Location	Resultant Version A
XXXXX0	00000	Position 3	XX00000XXX
XXXXX1	10000	Position 3	XX10000XXX
XXXXX2	20000	Position 3	XX20000XXX
XXXXX3	00000	Position 4	XXX00000XX
XXXXX4	00000	Position 5	XXXX00000X
XXXXX5	0000	Position 6	XXXXX00005
XXXXX6	0000	Position 6	XXXXX00006
XXXXX7	0000	Position 6	XXXXX00007
XXXXX8	0000	Position 6	XXXXX00008
XXXXX9	0000	Position 6	XXXXX00009



VERSION E



VERSION A EQUIVALENT

UPC/EAN SUPPLEMENTS

UPC and EAN bar codes can contain supplements that provide two or five digits of additional information. The supplements are located to the right of standard UPC/EAN labels. The reader can be programmed to either read or ignore the supplements.



APPENDIX F - EAN SPECIFICATIONS

The European Article Numbering system (EAN) is a superset of UPC. EAN has two versions: EAN-13 (13 digits) and EAN-8 (8 digits).



EAN 13



EAN 8

Country codes 00, 01, 03, 04, and 06 - 09 are assigned to the U.S. for compatibility with UPC.

APPENDIX G - INTERLEAVED 2 of 5 SPECIFICATIONS

The Interleaved 2 of 5 bar code symbology is a numeric code (0 - 9) which has different start and stop characters. The name Interleaved 2 of 5 is derived from the fact that two characters are paired together using the bars to represent the first character and spaces to represent the second. Each character has two wide elements and three narrow elements.

CHARACTERISTICS:

- Character Set: Numeric only (0 - 9)
- Symbol Length: Variable (must be an even number of digits)
- Check Digit: Optional
- Bi-directional Decoding: Yes
- Maximum Density: 18 char./inch
(using .0075 inch narrow element)

CHARACTER SET:

The following table illustrates the data patterns. A "1" represents a wide bar or space and a "0" represents a narrow bar or space.

CHARACTER	PATTERN
0	00110
1	10001
2	01001
3	11000
4	00101
5	10100
6	01100
7	00011
8	10010
9	01010
start	0000
stop	100



OPTIONAL CHECK DIGIT:

Interleaved 2 of 5 may contain an optional check digit. The reader supports two types of check digits:

1. Uniform Symbology Specification (USS) - calculated as modulo 10 check digit based on 3-1-3 weightings.
2. Optical Product Code Council (OPCC) - calculated as modulo 10 check digit based on 2-1-2 weightings.

USS CHECK DIGIT CALCULATION:

1. From right to left, sum the digits in the odd positions.
2. Multiply this sum by 3.
3. From right to left, sum the digits in the even positions.
4. Add this sum to the product of step 2.
5. The modulo-10 check digit is the smallest number which when added to the sum of Step 4 produces a multiple of 10.

EXAMPLE: USS check digit. Sample bar code data: 513827

1. $7 + 8 + 1 = 16$
2. $16 \times 3 = 48$
3. $2 + 3 + 5 = 10$
4. $48 + 10 = 58$
5. $58 + 2 = 60$ (check digit = 2)
Therefore: Data + check digit = 5138272

NOTE: A leading zero will be required to make it an even number of characters. The resulting bar code will be: 05138272

OPCC CHECK DIGIT CALCULATION:

1. From right to left, assign every digit a weighting factor from the sequence: 2,1,2,1,2,1,2,1,...
2. Multiply each digit by its weighting factor.
3. Sum the products in step 2, treating two digit products as the sum of the individual digits.
4. The check digit is the smallest number which when added to the sum of step 3 produces a multiple of 10.

EXAMPLE: OPCC check digit

Sample bar code data: 020489713

1. Assign weighting factors: 020489713 212121212
2. Calculate the products: 0 2 0 4 16 9 14 1 6
3. Sum the products: $0+2+0+4+16+9+14+1+6 = 34$
4. $34 + 6 = 40$ (check digit = 6)
Therefore: Data + check digit = 0204897136

APPENDIX H - CODABAR SPECIFICATIONS

The Codabar bar code symbology is a numeric code (0 - 9) that also contains six special characters and four start/stop characters. The start/stop characters may or may not be transmitted. Characters are constructed of four bars and three spaces. Codabar is commonly used in libraries, blood banks, cotton industry, and the transportation industry.

CHARACTERISTICS:

- Character Set: 10 digits (0 - 9)
6 special characters (- \$: / . +)
4 stop/start characters (a b c d)
- Symbol Length: Variable
- Check Digit: Optional
- Bi-directional Decoding: Yes
- Maximum Density: 12.8 char./inch
(using .0075 inch narrow element)

CHARACTER SET:

The following table illustrates the data patterns. A "1" represents a wide bar or space and a "0" represents a narrow bar or space.

CHARACTER	PATTERN
0	000011
1	0000110
2	0001001
3	1100000
4	0010010
5	1000010
6	0100001
7	0100100
8	0110000
9	1001000
-	0001100
\$	0011000
:	1000101
/	1010001
.	1010100
+	0010101
a	0011010
b	0101001
c	0001011
d	0001110



A123456B

APPENDIX I - CODE 128 SPECIFICATIONS

The CODE 128 symbology is a variable length alphanumeric code containing the full 128 ASCII character set. Each character is made up of 11 modules containing three bars and three spaces. Bars and spaces can be from 1 to 4 modules wide. Three different start characters are used to select one of three character sets. Code 128 is the bar code of choice for new applications.

CHARACTERISTICS:

Character Set: All 128 ASCII characters
4 function characters
4 code set selection characters
3 start/stop characters

Symbol Length: Variable

Check Character: 1

Bi-directional Decoding: Yes

Maximum Density: 12.1 alphanumeric char./inch
24.2 numeric digits/inch
(using .0075 inch module element)



0123456789



ABCD123

UCC-128 MOD 10 SERIAL SHIPPING CONTAINER CODE:

FORMAT:

STARTC FNC1 000001234555555555 8 C STOP
(1) (2) (3) (4) (5) (6)

1. Start Code "C"4. MOD 10 Check Digit
2. FNC1 Character 5. MOD 103 Check Digit
3. 19 Digits 6. Stop Code



0000012345555555558

CHARACTER SET:

The following table contains the character set for Code 128 subsets A, B, and C:

CODE 128 (USD-6)

VALUE	CODE A	CODE B	CODE C	BAR PATTERN					
				B	S	B	S	B	S
0	SP	SP	00	2	1	2	2	2	2
1	!	!	01	2	2	2	1	2	2
2	"	"	02	2	2	2	2	2	1
3	#	#	03	1	2	1	2	2	3
4	\$	\$	04	1	2	1	3	2	2
5	%	%	05	1	3	1	2	2	2
6	&	&	06	1	2	2	2	1	3
7	'	'	07	1	2	2	3	1	2
8	((08	1	3	2	2	1	2
9))	09	2	2	1	2	1	3
10	*	*	10	2	2	1	3	1	2
11	+	+	11	2	3	1	2	1	2
12	,	,	12	1	1	2	2	3	2
13	-	-	13	1	2	2	1	3	2
14	.	.	14	1	2	2	2	3	1
15	/	/	15	1	1	3	2	2	2
16	0	0	16	1	2	3	1	2	2
17	1	1	17	1	2	3	2	2	1
18	2	2	18	2	2	3	2	1	1
19	3	3	19	2	2	1	1	3	2
20	4	4	20	2	2	1	2	3	1
21	5	5	21	2	1	3	2	1	2
22	6	6	22	2	2	3	1	1	2
23	7	7	23	3	1	2	1	3	1
24	8	8	24	3	1	1	2	2	2
25	9	9	25	3	2	1	1	2	2
26	:	:	26	3	2	1	2	2	1
27	;	;	27	3	1	2	2	1	2
28	<	<	28	3	2	2	1	1	2
29	=	=	29	3	2	2	2	1	1
30	>	>	30	2	1	2	1	2	3
31	?	?	31	2	1	2	3	2	1
32	@	@	32	2	3	2	1	2	1
33	A	A	33	1	1	1	3	2	3
34	B	B	34	1	3	1	1	2	3
35	C	C	35	1	3	1	3	2	1
36	D	D	36	1	1	2	3	1	3
37	E	E	37	1	3	2	1	1	3
38	F	F	38	1	3	2	3	1	1
39	G	G	39	2	1	1	3	1	3
40	H	H	40	2	3	1	1	1	3
41	I	I	41	2	3	1	3	1	1
42	J	J	42	1	1	2	1	3	3
43	K	K	43	1	1	2	3	3	1
44	L	L	44	1	3	2	1	3	1
45	M	M	45	1	1	3	1	2	3

CODE 128 (USD-6)

VALUE	CODE A	CODE B	CODE C	BAR PATTERN					
				B	S	B	S	B	S
46	N	N	46	1	1	3	3	2	1
47	O	O	47	1	3	3	1	2	1
48	P	P	48	3	1	3	1	2	1
49	Q	Q	49	2	1	1	3	3	1
50	R	R	50	2	3	1	1	3	1
51	S	S	51	2	1	3	1	1	3
52	T	T	52	2	1	3	3	1	1
53	U	U	53	2	1	3	1	3	1
54	V	V	54	3	1	1	1	2	3
55	W	W	55	3	1	1	3	2	1
56	X	X	56	3	3	1	1	2	1
57	Y	Y	57	3	1	2	1	1	3
58	Z	Z	58	3	1	2	3	1	1
59	[[59	3	3	2	1	1	1
60	\	\	60	3	1	4	1	1	1
61]]	61	2	2	1	4	1	1
62	^	^	62	4	3	1	1	1	1
63	_	_	63	1	1	1	2	2	4
64	NUL	.	64	1	1	1	4	2	2
65	SOH	a	65	1	2	1	1	2	4
66	STX	b	66	1	2	1	4	2	1
67	ETX	c	67	1	4	1	1	2	2
68	EOT	d	68	1	4	1	2	2	1
69	ENQ	e	69	1	1	2	2	1	4
70	ACK	f	70	1	1	2	4	1	2
71	BEL	g	71	1	2	2	1	1	4
72	BS	h	72	1	2	2	4	1	1
73	HT	i	73	1	4	2	1	1	2
74	LF	j	74	1	4	2	2	1	1
75	VT	k	75	2	4	1	2	1	1
76	FF	l	76	2	2	1	1	1	4
77	CR	m	77	4	1	3	1	1	1
78	SO	n	78	2	4	1	1	1	2
79	SI	o	79	1	3	4	1	1	1
80	DLE	p	80	1	1	1	2	4	2
81	DC1	q	81	1	2	1	1	4	2
82	DC2	r	82	1	2	1	2	4	1
83	DC3	s	83	1	1	4	2	1	2
84	DC4	t	84	1	2	4	1	1	2
85	NAK	u	85	1	2	4	2	1	1
86	SYN	v	86	4	1	1	2	1	2
87	ETB	w	87	4	2	1	1	1	2
88	CAN	x	88	4	2	1	2	1	1
89	EM	y	89	2	1	2	1	4	1
90	SUB	z	90	2	1	4	1	2	1

CODE 128 (USD-6)

VALUE	CODE A	CODE B	CODE C	BAR PATTERN					
				B	S	B	S	B	S
91	ESC	{	91	4	1	2	1	2	1
92	FS		92	1	1	1	1	4	3
93	GS	}	93	1	1	1	3	4	1
94	RS	~	94	1	3	1	1	4	1
95	US	DEL	95	1	1	4	1	1	3
96	FNC 3	FNC 3	96	1	1	4	3	1	1
97	FNC 2	FNC 2	97	4	1	1	1	1	3
98	SHIFT	SHIFT	98	4	1	1	3	1	1
99	CODE C	CODE C	99	1	1	3	1	4	1
100	CODE B	FNC 4	CODE B	1	1	4	1	3	1
101	FNC 4	CODE A	CODE A	3	1	1	1	4	1
102	FNC 1	FNC 1	FNC 1	4	1	1	1	3	1

			B	S	B	S	B	S
103	START (CODE A)		2	1	1	4	1	2
104	START (CODE B)		2	1	1	2	1	4
105	START (CODE C)		2	1	1	2	3	2

		B	S	B	S	B	S	B
	STOP	2	3	3	1	1	1	2

APPENDIX J - CODE 93 SPECIFICATIONS

The Code 93 bar code symbology is a variable length alphanumeric code containing the full 128 ASCII character set. Each character is made up of 9 modules with three bars and three spaces. The bars can be 1, 2, or 3 modules wide except for the start/stop character. The spaces can be 1, 2, 3, or 4 modules wide. Code 93 bar codes contain a mandatory two digits for data integrity.

CHARACTERISTICS

Character Set:	128 ASCII character set
Symbol Length:	Variable
Check Digit:	2
Bi-directional Decoding:	Yes
Maximum Density:	14.8 char./inch (using .0075 inch narrow element)

CHARACTER SET

The following tables represent Code 93 data. Table 1 defines all of the USS-93 character assignments. Table 2 shows the full ASCII character set with the special control characters.

Table 1. USS-93 Character Assignments

Character	Value (for Check Digit Purposes)	Pattern	Encodation	Character	Value (for Check Digit Purposes)	Pattern	Encodation
0	0		100010100	O	24		100101100
1	1		101001000	P	25		100010110
2	2		101000100	Q	26		110110100
3	3		101000010	R	27		110110010
4	4		100101000	S	28		110101100
5	5		100100100	T	29		110100110
6	6		100100010	U	30		110010110
7	7		101010000	V	31		110011010
8	8		100010010	W	32		101101100
9	9		100001010	X	33		101100110
A	10		110101000	Y	34		100110110
B	11		110100100	Z	35		100110100
C	12		110100010	-	36		100101110
D	13		110010100	.	37		111010100
E	14		110010010	Space	38		111010010
F	15		110001010	\$	39		111001010
G	16		101101000	/	40		101101110
H	17		101100100	+	41		101110110
I	18		101100010	%	42		110101110
J	19		100110100	Ⓢ	43		100100110
K	20		100011010	Ⓢ	44		111010100
L	21		101011000	Ⓣ	45		111010110
M	22		101001100	Ⓟ	46		100110010
N	23		101000110	□			101011110

Table 2. Encoding the Full ASCII Character Set

ASCII	CODE 93	ASCII	CODE 93	ASCII	CODE 93	ASCII	CODE 93
NUL	(%) U	SP	Space	@	(%) V	`	(%) W
SOH	(\$) A	!	(/) A	A	A	a	(+) A
STX	(\$) B	"	(/) B	B	B	b	(+) B
ETX	(\$) C	#	(/) C	C	C	c	(+) C
EOT	(\$) D	\$	(/) \$	D	D	d	(+) D
ENQ	(\$) E	%	(/) %	E	E	e	(+) E
ACK	(\$) F	&	(/) F	F	F	f	(+) F
BEL	(\$) G	'	(/) G	G	G	g	(+) G
BS	(\$) H	((/) H	H	H	h	(+) H
HT	(\$) I)	(/) I	I	I	i	(+) I
LF	(\$) J	*	(/) J	J	J	j	(+) J
VT	(\$) K	+	(/) +	K	K	k	(+) K
FF	(\$) L	,	(/) L	L	L	l	(+) L
CR	(\$) M	-	(/) -	M	M	m	(+) M
SO	(\$) N	.	(/) .	N	N	n	(+) N
SI	(\$) O	/	(/) /	O	O	o	(+) O
DLE	(\$) P	0	(/) 0	P	P	p	(+) P
DC1	(\$) Q	1	(/) 1	Q	Q	q	(+) Q
DC2	(\$) R	2	(/) 2	R	R	r	(+) R
DC3	(\$) S	3	(/) 3	S	S	s	(+) S
DC4	(\$) T	4	(/) 4	T	T	t	(+) T
NAK	(\$) U	5	(/) 5	U	U	u	(+) U
SYN	(\$) V	6	(/) 6	V	V	v	(+) V
ETB	(\$) W	7	(/) 7	W	W	w	(+) W
CAN	(\$) X	8	(/) 8	X	X	x	(+) X
EM	(\$) Y	9	(/) 9	Y	Y	y	(+) Y
SUB	(\$) Z	:	(/) Z	Z	Z	z	(+) Z
ESC	(%) A	;	(%) F	[(%) K	{	(%) P
FS	(%) B	<	(%) G	\	(%) L	:	(%) Q
GS	(%) C	=	(%) H]	(%) M	}	(%) R
RS	(%) D	>	(%) I	^	(%) N	~	(%) S
US	(%) E	?	(%) J	_	(%) O	DEL	(%) T



0123456789

APPENDIX K

CARD DATA FORMAT FOR TRANSACTION CARDS

	Recording Density (bits per inch)	Character Configuration (includes Parity)	Information Content (Max characters)
TRACK 1	210 bpi	7 bits per char.	79 alpha-numeric
TRACK 2	75 bpi	5 bits per char.	40 numeric
TRACK 3	210 bpi	5 bits per char.	107 numeric

TRACK	COMMON FIELD ENCODING							
1	Start Sentinel	Account Number	Field Separator	Name	Field Separator	Exp Date & Addit'l Data	End Sentinel	LRC Char.
2	Start Sentinel	Account Number	Field Separator	Exp Date & Addit'l Data	End Sentinel	LRC Char.		
3	Start Sentinel	Account Number	Field Separator	Use & Security*	Addit'l Data*	End Sentinel	LRC Char.	

NOTES: Track 3 Use & Security Data includes the following:

Country Code (opt)	3 or FS
Currency Code	3
Currency Exponent	1
Amt. Authorized Per Cycle	4
Amt. Remaining This Cycle	4
Cycle Begin (Validity Date)	4
Cycle Length	2
Reentry Count	1
*Pin Control Param. (opt.)	6 or FS
Interchange Control	1
Acct. No. Service Restriction	2
SAN-1 Service Restriction	2
SAN-2 Service Restriction	2
Expiration Date (opt.)	4 or FS
Card Sequence Number	1
Card Security No. (opt)	9 or FS

Track 3 Additional Data includes the following:

First Subsidiary Acct. No. (opt.)	
Second Subsidiary Acct No. (opt.)	
Relay Marker	1
Cryptographic Chk Digits (opt.)	6 or FS
Discretionary Data	

NON-STANDARD USE OF MAGNETIC STRIPE DATA

Many applications exist for non-standard use of the magnetic stripe card, such as access control, inventory, data entry, insurance information, medical, etc.... In those applications the data content, code, format and even densities can be changed to fit the application.

APPENDIX L - SOURCES OF BAR CODE AND MAGNETIC STRIPE STANDARDS

ABC (American Blood Commission)
1117 North 19th Street
Suite 501
Arlington, VA 22209-1749
(703) 522-8414

- * Committee for Commonality in Blood Banking Automation (CCBBA)
Report (Codabar)

AIM (Automatic Identification Manufacturers Inc.)
1326 Freeport Road
Pittsburgh, PA 15238
(412) 963-8588

- * USD-1 (Interleaved 2 of 5)
- * USD-2 (A Subset of Code 39)
- * USD-3 (Code 39)
- * USD-4 (Codabar)
- * USD-6 (Code 128)
- * USD-7 (Code 93)
- * USD-8 (Code 11)

AIAG (Automotive Industry Action Group)
26200 Lahser Road
Suite 200
Southfield, MI 48034
(313) 358-3570

- * AIAG-B-1 1984 Bar Code Symbology Standard
- * AIAG-B-3 Shipping/Parts Identification Label Standard
- * AIAG-B-6 Standard for Bar Code Data Identifiers

ANSI (American National Standards Institute)
11 West 42nd Street
New York, NY 10036
(212)624-4900

- * ANSI MH10.8M-1983 Specification for Bar Code Symbols on Transport Packages and Unit Loads. (Code 39, Interleaved 2 of 5, Codabar)
- * ANSI X3A1.3 Bar Code Print Quality (Draft)

- * ANSI X4.16-1983 Specifications for Magnetic Stripe Encoding (Financial Transaction Cards)
- * ANSI X4.13-1983 Specifications for Financial Services - Financial Transaction Cards
- * ANSI X9.1-1984 Specifications for Track 3 Magnetic Stripe Data Content

DOD (Department of Defense)
 Naval Publications & Forms Center
 5801 Tabor Avenue
 Philadelphia, PA 19120
 (215) 697-2000

- * MIL-STD-1189A (B) - Standard Department of Defense Bar Code Symbology
- * MIL-STD-129J - Military Standard - Marking for Shipment & Storage - Bar Code Markings
- * FED-STD-123D - Federal Standard - Marking for Shipment (Civil Agencies) Bar Code Markings

EAN (International Article Numbering Association)
 Rue des Colonies, Bte 8
 1000 Brussels
 BELGIUM
 011 322 218 7585

HIBCC (Health Industry Business Communications Council)
 5110 North 40th Street, Suite 250
 Phoenix, AZ 85018
 (602) 381-1091

- * HIBC Supplier Labeling Standard
- * HIBC Provider Applications Standard
- * HIBC Guidelines

UCC (Uniform Code Council)
 8163 Old Yankee Rd., Suite J
 Dayton, OH 45458
 (513) 435-3870

- * UPC Symbol Specification
- * UPC Location Guidelines
- * UPC Shipping Container Symbol Specifications Manual
- * UPC Industrial Code Guidelines Manual
- * UPC Film Master Verification Manual